

AIRDROP OF SUPPLIES AND EQUIPMENT:

RIGGING STINGER WEAPON SYSTEMS AND MISSILES

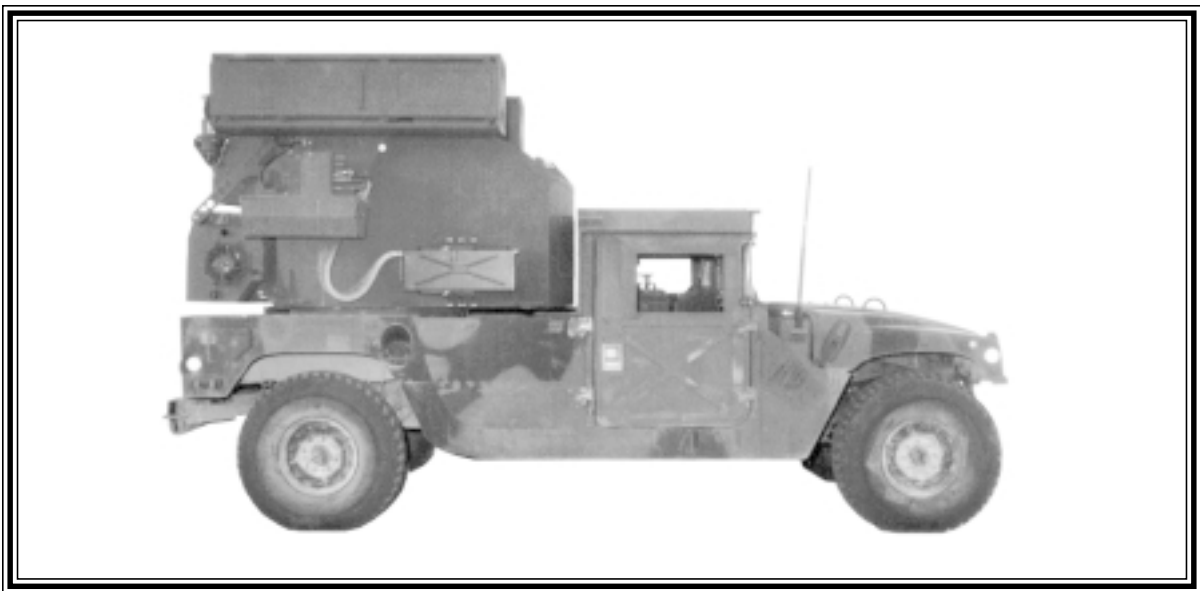

DISTRIBUTION RESTRICTION: Approved for public release; distribution is unlimited.

**HEADQUARTERS
DEPARTMENT OF THE ARMY
DEPARTMENT OF THE AIR FORCE**

HEADQUARTERS
DEPARTMENT OF THE ARMY
DEPARTMENT OF THE AIR FORCE
Washington, DC, 29 December 2000

Change 4

**AIRDROP OF SUPPLIES AND EQUIPMENT:
RIGGING STINGER WEAPON SYSTEMS AND MISSILES**

1. This change adds the procedures for rigging the Avenger air defense weapons system on a 28-foot, Type V platform for low-velocity airdrop.
2. Change FM 10-550, 29 May 1984, as follows:

Remove old pages

Cover
i through v
1-1
6-1 and 6-2
6-11 and 6-12
7-1 through 7-71
Glossary-1

Insert new pages

Cover
i through vi
1-1
6-1 and 6-2
6-11 and 6-12
7-1 through 7-61
Glossary-1

3. New or changed material is identified by a vertical bar in the margin opposite the changed material.
4. File this transmittal sheet in the front of the publication.

By Order of the Secretary of the Army:

ERIC K. SHINSEKI
General, United States Army
Chief of Staff

Official:

JOEL B. HUDSON

*Administrative Assistant to the
Secretary of the Army*
0032001

DISTRIBUTION:

Active Army, Army National Guard, and U.S. Army Reserve: To be distributed in accordance with the initial distribution number 110932, requirements for FM 10-550.

**CHANGE
NO. 3**

**HEADQUARTERS
DEPARTMENT OF THE ARMY
DEPARTMENT OF THE AIR FORCE
Washington, DC, 28 June 1996**

AIRDROP OF SUPPLIES AND EQUIPMENT: RIGGING STINGER WEAPON SYSTEMS AND MISSILES

This change adds the procedures for rigging the Avenger air defense weapons system on a type V platform for low-velocity airdrop. This change also deletes procedures for rigging the Stinger weapon systems and missiles in A-21 containers using the wedge.

FM 10-550/TO 13C7-22-71, 29 May 1984, is changed as follows:

1. New or changed material is identified by a vertical bar in the margin opposite the changed material.
2. Remove old pages and insert new pages as indicated below.

Remove old pages

i through v
1-1
3-1 and 3-2
3-9 through 3-11
4-1 through 4-10
6-11 and 6-12

Glossary-1
References-1

Insert new pages

i through v
1-1
3-1 and 3-2
3-9 through 3-11
4-1 through 4-10
6-11 and 6-12
7-1 through 7-71
Glossary-1
References-1 and References-2

3. File this transmittal sheet in front of the publication for reference purposes.

DISTRIBUTION RESTRICTION: Distribution authorized to US government agencies only to protect technical or operational information from automatic dissemination under the International Exchange Program or by other means. This determination was made on 30 April 1993. Other requests for this document will be referred to Airborne and Field Services Department, USA Quartermaster Center and School, 1010 Shop Road, Fort Lee, VA 23801-1502.

DESTRUCTION NOTICE: Destroy by any method that will prevent disclosure of contents or reconstruction of the document.

By Order of the Secretaries of the Army and the Air Force:

By Order of the Secretary of the Army:

Official:

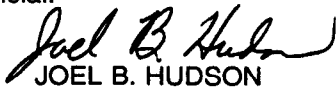

JOEL B. HUDSON

*Administrative Assistant to the
Secretary of the Army*

01976

DENNIS J. REIMER
*General, United States Army
Chief of Staff*

DISTRIBUTION:

Active Army, USAR, and ARNG: To be distributed in accordance with DA Form 12-11E, requirements for FM 10-550, *Airdrop of Supplies and Equipment: Rigging Stinger Weapon Systems and Missiles* (Qty rqr block no. 0932)

CHANGE
NO 2

HEADQUARTERS
DEPARTMENTS OF THE ARMY
AND THE AIR FORCE
Washington, DC, 20 September 1994

AIRDROP OF SUPPLIES AND EQUIPMENT RIGGING STINGER WEAPON SYSTEMS AND MISSILES

This change adds the procedures for rigging the 1 1/4-ton truck with stinger weapon systems and missiles on a type V platform for low-velocity airdrop. Also with this change, the C-5 aircraft may be used for low-velocity airdrop. See FM 10-500-2 for guidance when rigging loads for the C-5 aircraft.

FM 10-550/TO 13C7-22-71, 29 May 1984, is changed as follows:

1. New or changed material is identified by a vertical bar in the margin opposite the changed material.
2. Remove old pages and insert new pages as indicated below:

Remove old pages	Insert new pages
i through iv	i through v
Glossary-1	6-1 through 6-13
References-1	Glossary-1
	References-1

3. File this transmittal sheet in front of the publication for reference purposes.

DISTRIBUTION RESTRICTION: Distribution authorized to US government agencies only to protect technical or operational information from automatic dissemination under the International Exchange Program or by other means. This determination was made on 30 April 1993. Other requests for this document will be referred to Commander, US Army Quartermaster Center and School, ATTN: ATSM-SPT-I, Fort Lee, VA 23801-5036.

DESTRUCTION NOTICE: Destroy by any method that will prevent disclosure of contents or reconstruction of the document.

CHANGE
NO 1

DEPARTMENTS OF THE ARMY
AND THE AIR FORCE
Washington, DC, 14 February 1989

AIRDROP OF SUPPLIES AND EQUIPMENT: RIGGING STINGER WEAPON SYSTEMS AND MISSILES

This change adds procedures for rigging the Stinger weapon systems and missiles on a type V airdrop platform for LV and LAPE airdrop.

FM 10-550/TO 13C7-22-71, 29 May 1984, is changed as follows:

1. New or changed material is identified by a vertical bar in the margin opposite the changed material.
2. Remove old pages and insert new pages as indicated below:

Remove pages

i through iii
3-9 and 3-10
4-1 and 4-2
4-9 and 4-10

Glossary-1
References-1

Insert pages

i through iv
3-9 and 3-10
4-1 and 4-2
4-9 and 4-10
5-1 through 5-51

Glossary-1
References-1

3. File this transmittal sheet in front of the publication.

DISTRIBUTION RESTRICTION: Distribution authorized to US government agencies only to protect technical or operational information from automatic dissemination under the International Exchange Program or by other means. This determination was made on 4 February 1987. Other requests for this document will be referred to Commandant, US Army Quartermaster School, ATTN: ATSM-DTP, Fort Lee, Virginia 23801-5036.

DESTRUCTION NOTICE: Destroy by any method that will prevent disclosure of contents or reconstruction of the document.

FIELD MANUAL
No. 10-550
TECHNICAL ORDER
No. 13C7-22-71

HEADQUARTERS
DEPARTMENT OF THE ARMY
DEPARTMENT OF THE AIR FORCE
WASHINGTON, DC, 29 May 1984

**AIRDROP OF SUPPLIES AND EQUIPMENT:
RIGGING STINGER WEAPON SYSTEMS AND MISSILES**

TABLE OF CONTENTS

	Paragraph	Page
PREFACE		v
CHAPTER 1	INTRODUCTION	
	Description of Items	1-1
	Special Considerations	1-2
CHAPTER 2	RIGGING STINGER WEAPON SYSTEMS AND MISSILES	
Section I	RIGGING 1/4-TON TRUCK AND TRAILER WITH WEAPON SYSTEMS AND MISSILES FOR LOW-VELOCITY AIRDROP	
	Description of Load	2-1
	Preparing Platform and Installing Suspension Slings	2-2
	Constructing, Positioning, and Lashing Strongbacks	2-3
	Building and Placing Honeycomb Stacks	2-4
	Stowing Accompanying Load on Platform	2-5
	Preparing Load	2-6
	Setting Truck and Trailer on Platform	2-7
	Lashing Load	2-8
	Installing Load Cover	2-9
	Installing Antitumble Slings and Safety Suspension Slings	2-10
	Stowing Cargo Parachutes	2-11
	Installing Extraction System	2-12
	Installing Release Assembly	2-13
	Placing Extraction Parachute	2-14
	Marking Rigged Load	2-15
	Equipment Required	2-16
Section II	RIGGING 1/4-TON TRUCK AND TRAILER WITH WEAPON SYSTEMS AND MISSILES FOR LAPE AIRDROP	
	Description of Load	2-17
	Preparing Platform and Installing Bridle Plates	2-18
	Stowing Accompanying Load on Platform	2-19
	Building and Placing Honeycomb Stacks	2-20
	Preparing Load	2-21

DISTRIBUTION RESTRICTION: Approved for public release; distribution is unlimited.

	Paragraph	Page
	Setting Truck and Trailer on Platform	2-22 2-42
	Lashing Load	2-23 2-43
	Installing Attitude Control Bar	2-24 2-44
	Installing Extraction System	2-25 2-46
	Placing Extraction Parachutes	2-26 2-47
	Marking Rigged Load	2-27 2-47
	Equipment Required	2-28 2-48
CHAPTER 3	RIGGING STINGER WEAPON SYSTEMS AND MISSILES IN AN A-22 CARGO BAG FOR LOW-VELOCITY AIRDROP	
	Description of Load	3-1 3-1
	Preparing Skid and Honeycomb	3-2 3-1
	Positioning Weapons and Missiles	3-3 3-1
	Attaching Cargo Parachutes	3-4 3-10
	Rigged Load Data	3-5 3-10
	Equipment Required	3-6 3-11
CHAPTER 4	RIGGING STINGER WEAPON SYSTEMS AND MISSILES IN AN A-21 CARGO BAG FOR LOW-VELOCITY AIRDROP	
	Description of Load	4-1 4-1
	Preparing Skid and Honeycomb	4-2 4-1
	Rigging A-21 Cargo Bag	4-3 4-4
	Securing Load to Skid	4-4 4-9
	Attaching Cargo Parachute	4-5 4-9
	Rigged Load Data	4-6 4-9
	Equipment Required	4-7 4-11
CHAPTER 5	RIGGING 1/4-TON TRUCK AND TRAILER WITH STINGER WEAPON SYSTEMS AND MISSILES ON A TYPE V PLATFORM	
Section I	LOW-VELOCITY AIRDROP	
	Description of Load	5-1 5-1
	Preparing Platform	5-2 5-1
	Building and Placing Honeycomb Stacks	5-3 5-2
	Stowing Accompanying Load on Platform	5-4 5-6
	Preparing Truck	5-5 5-7
	Preparing Trailer	5-6 5-12
	Setting Truck and Trailer on Platform	5-7 5-19
	Lashing Truck and Trailer to Platform	5-8 5-20
	Installing Load Cover	5-9 5-22
	Installing Suspension Slings and Antitumble Slings	5-10 5-23
	Stowing Cargo Parachutes	5-11 5-25
	Installing Extraction System	5-12 5-28
	Installing Release Assembly	5-13 5-29

	Paragraph	Page
	Placing Extraction Parachute	5-14 5-30
	Installing Emergency Restraints	5-15 5-30
	Marking Rigged Load	5-16 5-30
	Equipment Required	5-17 5-32
Section II	LAPE AIRDROP	
	Description of Load	5-18 5-33
	Preparing Platform	5-19 5-34
	Stowing Accompanying Load on Platform	5-20 5-34
	Building and Placing Honeycomb Stacks	5-21 5-37
	Preparing Truck and Trailer	5-22 5-41
	Setting Truck and Trailer on Platform	5-23 5-44
	Lashing Truck and Trailer to Platform	5-24 5-46
	Installing ACB	5-25 5-48
	Installing Extraction System	5-26 5-48
	Placing Extraction Parachute	5-27 5-48
	Marking Rigged Load	5-28 5-49
	Equipment Required	5-29 5-49
CHAPTER 6	RIGGING 1 1/4-TON TRUCK WITH STINGER WEAPON SYSTEMS AND MISSILES FOR LOW-VELOCITY AIRDROP	
	Description of Load	6-1 6-1
	Preparing Platform, Preparing and Positioning Honeycomb Stacks, and Preparing Truck	6-2 6-1
	Rigging Weapon Systems and Truck Equipment in Truck	6-3 6-1
	Lifting, Positioning, and Lashing the Truck	6-4 6-1
	Installing and Safetying Suspension Slings	6-5 6-11
	Installing Cargo Parachutes, Extraction System, Provisions for Emergency Restraint, Cargo Parachute Release, and Cargo Extraction Parachutes	6-6 6-11
	Marking Rigged Load	6-7 6-11
	Equipment Required	6-8 6-11
CHAPTER 7	RIGGING 1 1/4-TON TRUCK WITH AN AVENGER AIR DEFENSE WEAPON SYSTEM ON A 28-FOOT, TYPE V PLATFORM FOR LOW-VELOCITY AIRDROP	
	Description of Load	7-1 7-1
	Preparing Platform	7-2 7-1
	Preparing and Positioning Honeycomb Stacks and Strongback	7-3 7-3
	Preparing Truck	7-4 7-8
	Preparing Turret	7-5 7-18
	Positioning Truck on Platform and Installing the Drive Off Aid	7-6 7-20
	Lashing Ramps to Platform	7-7 7-21
	Lashing Truck	7-8 7-22

	Paragraph	Page
Lashing Turret	7-10	7-31
Installing Supports for Guns, Laser Range Finder, and Environmental Control Unit	7-11	7-37
Covering Turret Canopy	7-12	7-44
Suspension Slings Installed and Safetied	7-13	7-47
Stowing Cargo Parachutes	7-14	7-51
Installing Extraction System	7-15	7-54
Installing Release System	7-16	7-55
Placing Extraction Parachute	7-17	7-56
Installing Provisions for Emergency Restraint	7-18	7-56
Marking Rigged Load	7-19	7-56
Equipment Required	7-20	7-56

GLOSSARY Glossary 1

REFERENCES References 1

PREFACE

SCOPE

This manual tells and shows how to prepare and rig the Stinger weapon systems and missiles in A-21 and A-22 cargo bags, and on the type II and type V platforms for low-velocity airdrop from C-5, C-130, C-141, and C-17 aircraft. It tells and shows how to rig the stinger weapon systems and missiles on LAPE and type V platforms for LAPE airdrop from C-130 aircraft. This manual tells and shows how to rig the Avenger air defense weapon system with the modified environmental control unit for low-velocity airdrop from the C-17, C-5, C-141, and C-130 aircraft. This manual is designed for use by all parachute riggers.

USER INFORMATION

The proponent of this publication is HQ TRADOC. You are encouraged to report any errors or omissions and to suggest ways to make this a better manual. Army personnel, send your comments on DA Form 2028 directly to:

Director
Aerial Delivery and Field Services Department
USA Quartermaster Center and School
1010 Shop Road
Fort Lee, Virginia 23801-1502

Air Force personnel, send your reports on AFTO Form 22 through:

Headquarters
Air Mobility Command (AMC/DOKT)
402 Scott Drive, Unit 3A1
Scott AFB, Illinois 62225-5302

Air Force personnel in Special Operations Command, send your reports on AFTO Form 22 through:

HQ AFSOC/DOXT
100 Bartley St., Suite 260
Hurlburt Field, Florida 32544-5273

CHAPTER 1

INTRODUCTION

1-1. Description of Items

The description of the items covered in this manual is as follows:

- a. The Stinger missile, in a wooden box, weighs 74 pounds; it is 67 inches long, 14 inches wide, and 12 inches high.
- b. The Stinger weapon system, in a metal case, weighs 87 pounds; it is 66 inches long, 13 inches wide, and 13 inches high.
- c. The M151, 1/4-ton truck weighs 2,410 pounds. It is 133 inches long, 64 inches wide, and 71 inches high (reducible to 52 inches).
- d. The M416, 1/4-ton trailer weighs 570 pounds. It is 109 inches long, 61 inches wide, and 44 inches high.
- e. The M 998, 1 1/4-ton HMMWV-series truck weighs 5,500 pounds. It is 185 inches long, 85 inches wide, and 70 inches high.
- f. The M1097, 1 1/4-ton, HMMWV-series truck used in the Avenger air defense weapon system weighs between 5,750 pounds and 5,900 pounds. It is 188.5 inches long, 86 inches wide, and 72 inches high. This truck with the Avenger turret mounted is 104 inches high.

- g. The Avenger weapon system turret is 69.25 inches high, when removed from the truck. It is 85 inches wide and 86.6 inches long. The Avenger turret with the modified Environmental Control Unit (ECU) is 91 inches long.

1-2. Special Considerations

CAUTION: Only ammunition listed in FM 10-500-53/MCRP 4-3.8/TO 13C7-18-41 may be airdropped.

- a. The loads covered in this manual may include hazardous materials as defined in AFJMAN 24-204/TM 38-250. If included, the hazardous material must be packaged, marked, and labeled as required by AFJMAN 24-204/TM-38-250.
- b. FM 10-517/TO 13C7-1-111 must be used to rig loads that include HMMWV series trucks.
- c. A copy of this manual must be available to the joint airdrop inspectors during the before- and after-loading inspections.

CHAPTER 3

RIGGING STINGER WEAPON SYSTEMS AND MISSILES IN AN A-22 CARGO BAG FOR LOW-VELOCITY AIRDROP

3-1. Description of Load

Four Stinger weapon systems and two missiles are rigged in an A-22 cargo bag with a G-12E cargo parachute.

NOTE: This load can only be dropped in a single-stick configuration (non-CVRS).

3-2. Preparing Skid and Honeycomb

Prepare the skid and honeycomb as shown in Figures 3-1 through 3-6.

3-3. Positioning Weapons and Missiles

Position the weapons and missiles as shown in Figures 3-7 through 3-9.

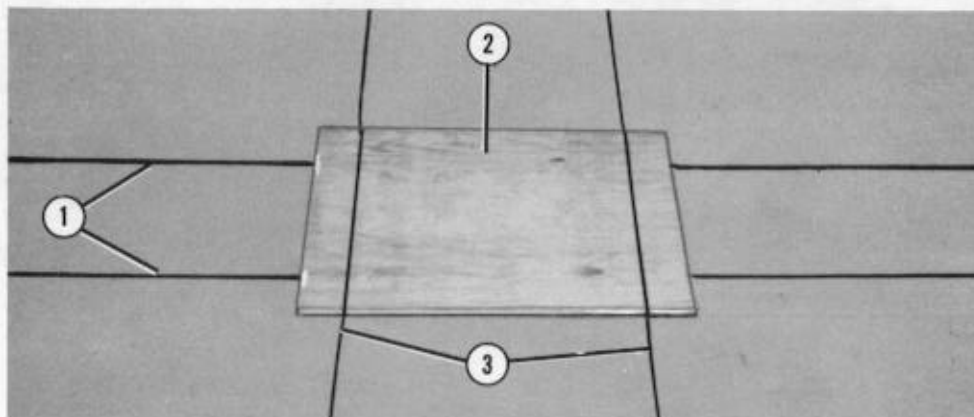

- ① Place two 15-foot lengths of steel strapping 36 inches apart.

NOTE: Be sure that the steel strapping is 6 inches from the outside edges of the plywood, measured from the outside edge of the steel strapping. Failure to maintain these distances will result in rejection of the load.

- ② Place a 3/4- by 48- by 66-inch piece of plywood on top of and parallel to the steel strapping.
- ③ Place two 15-foot lengths of steel strapping on top of the plywood along the 48-inch sides and 56 inches apart.

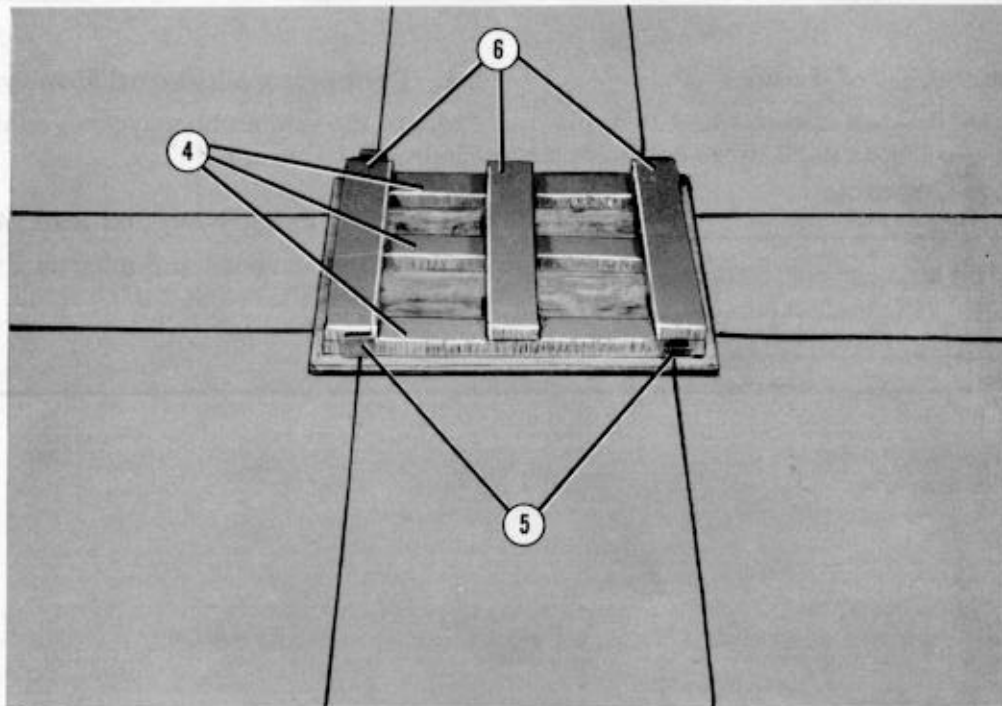

- ④ Glue three 6- by 62-inch pieces of honeycomb to the skid. Center the first piece of honeycomb on the skid and place the other two pieces 2 inches from the 66-inch side of the skid.
- ⑤ Set a piece of cardboard between the honeycomb and the steel strapping.
- ⑥ Glue three 8- by 44-inch pieces of honeycomb across the first layer of honeycomb. Center the first piece of honeycomb, and place the other two pieces flush with the ends of the first layer of honeycomb.

Figure 3-2. First and second layers of honeycomb glued in place

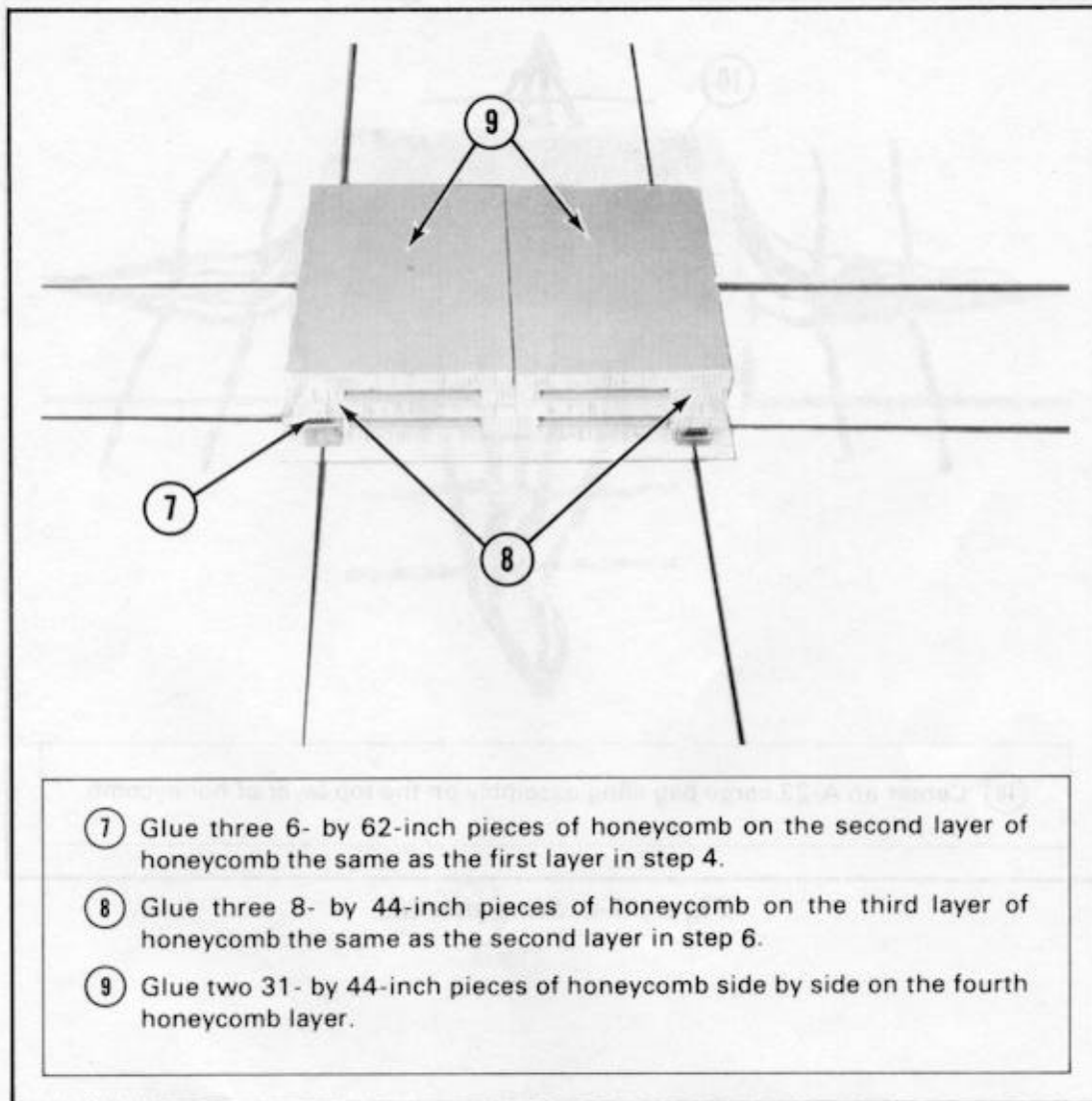

- ⑦ Glue three 6- by 62-inch pieces of honeycomb on the second layer of honeycomb the same as the first layer in step 4.
- ⑧ Glue three 8- by 44-inch pieces of honeycomb on the third layer of honeycomb the same as the second layer in step 6.
- ⑨ Glue two 31- by 44-inch pieces of honeycomb side by side on the fourth honeycomb layer.

Figure 3-3. Third, fourth, and fifth layers of honeycomb glued in place.

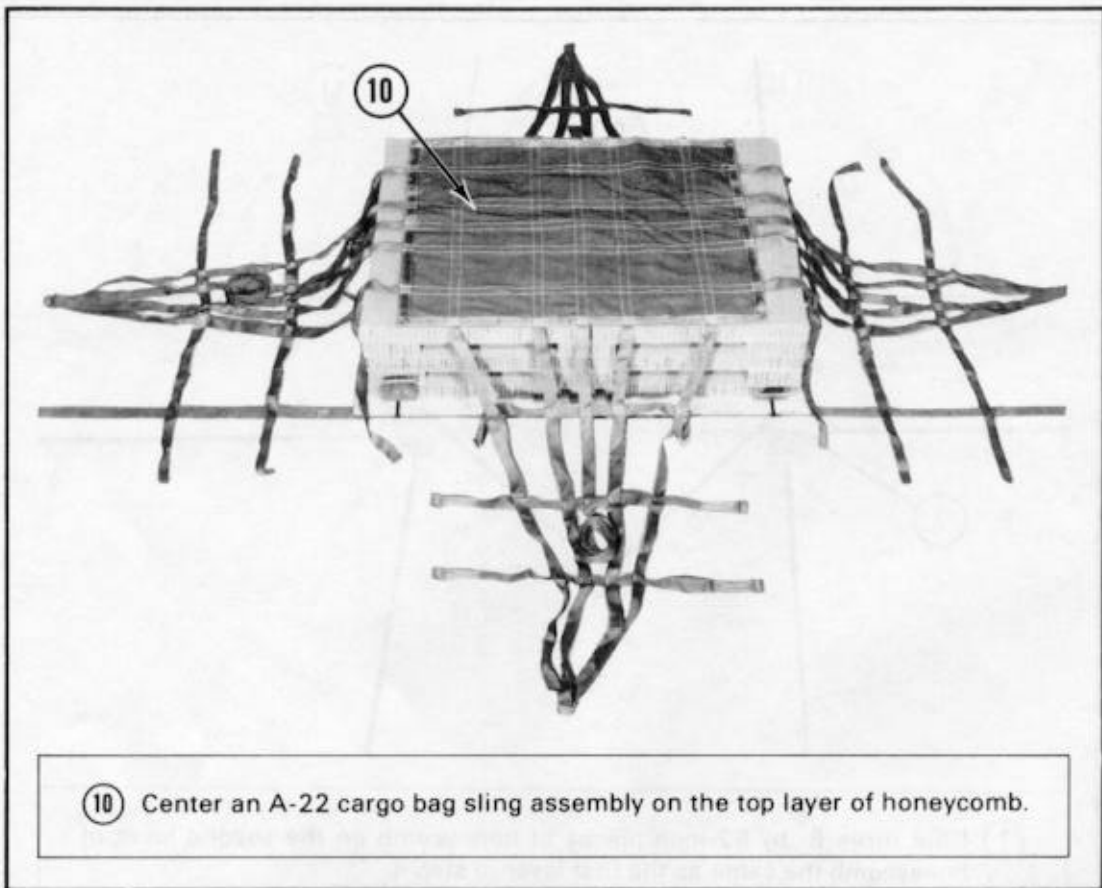

Figure 3-4. Sling placed.

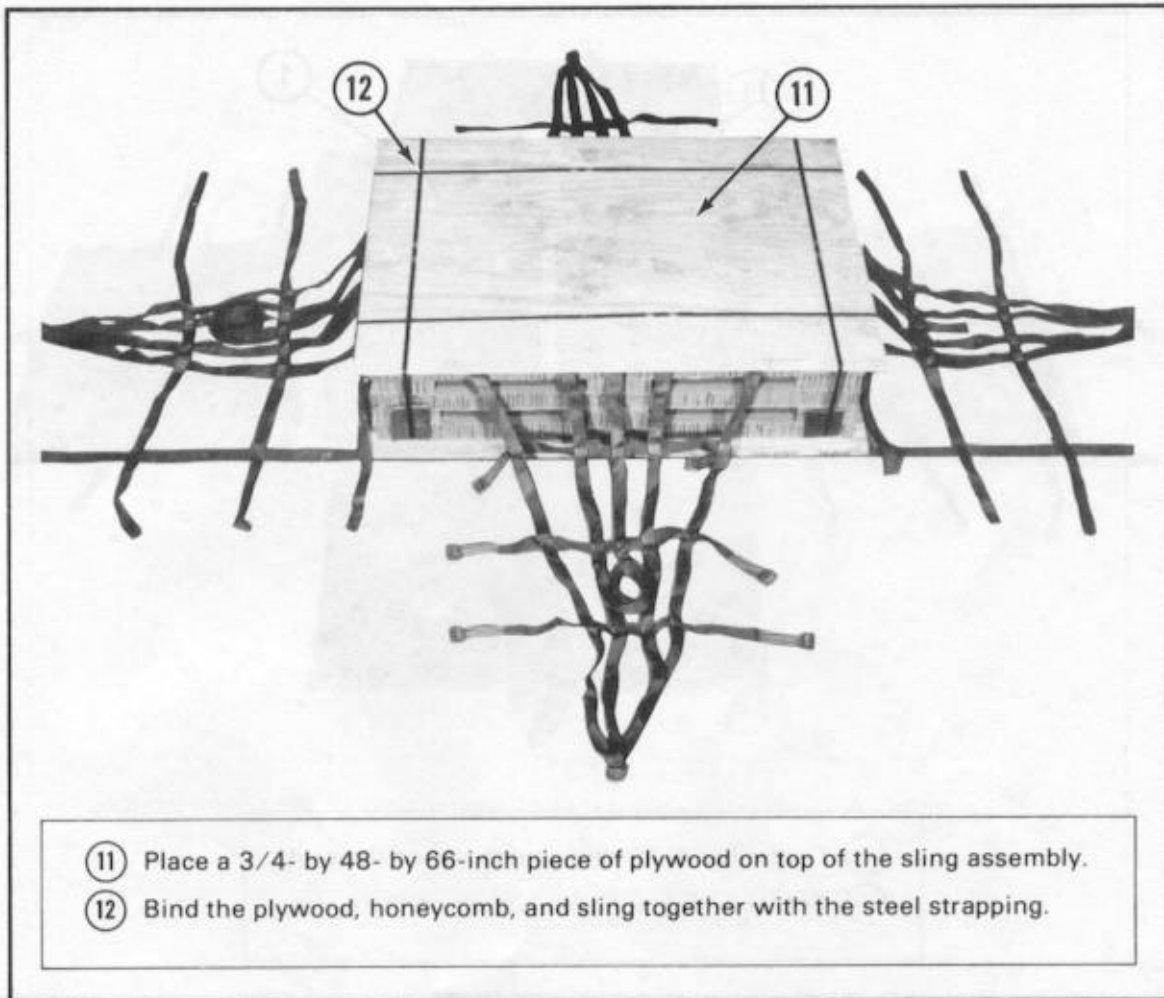

Figure 3-5. Skid prepared.

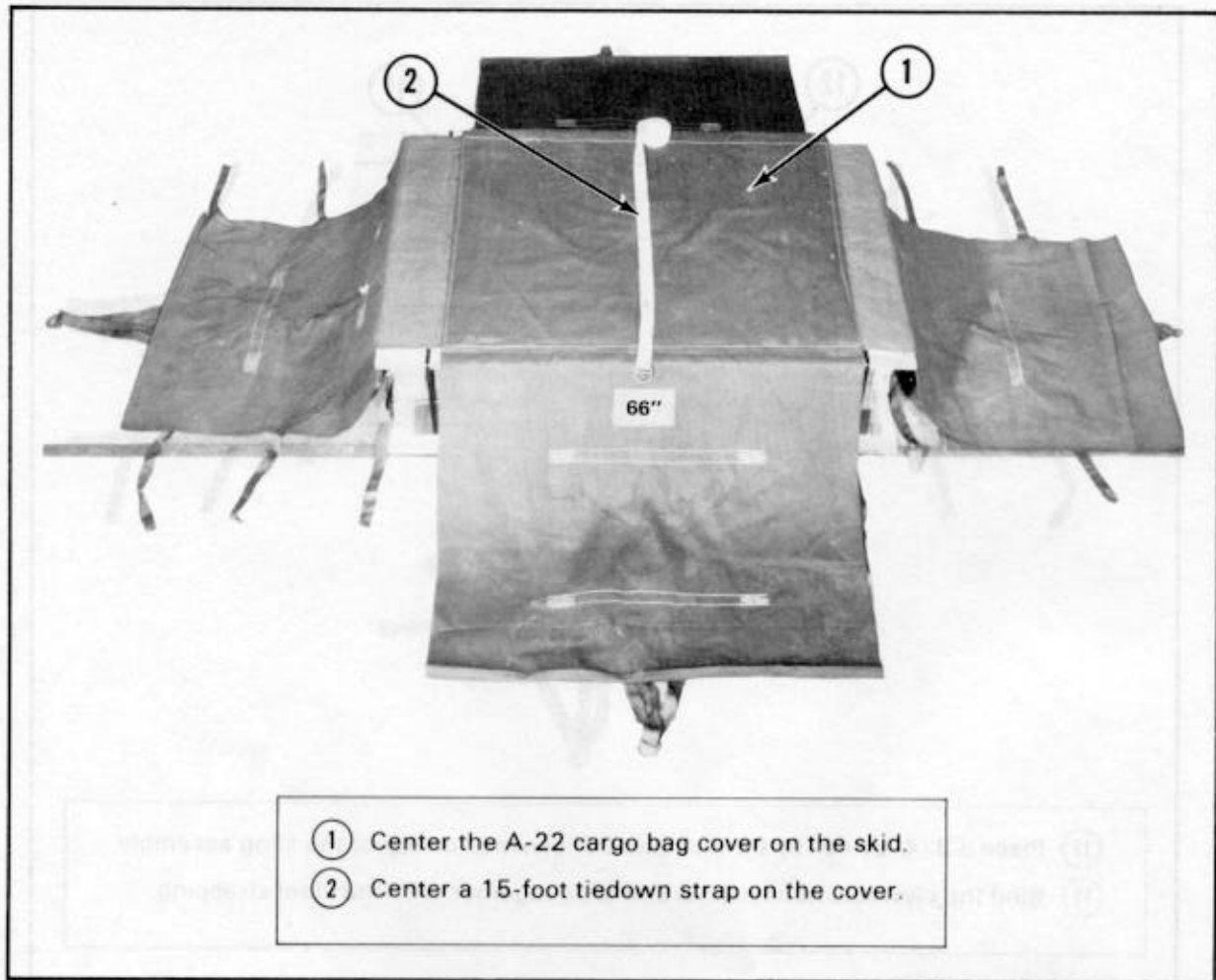

Figure 3-6. Cover and tiedown strap placed.

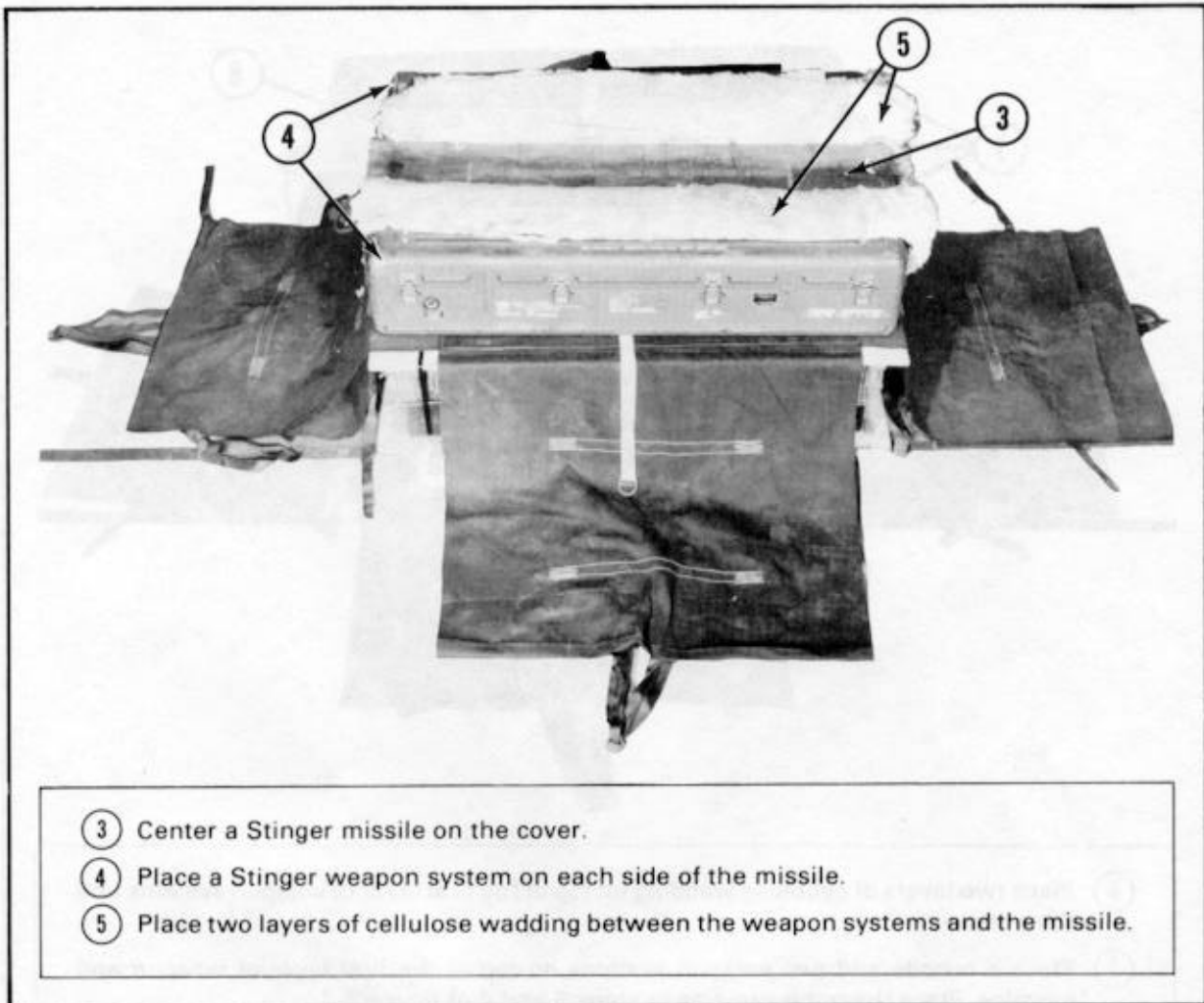

Figure 3-7. One missile and two weapon systems placed as first layer.

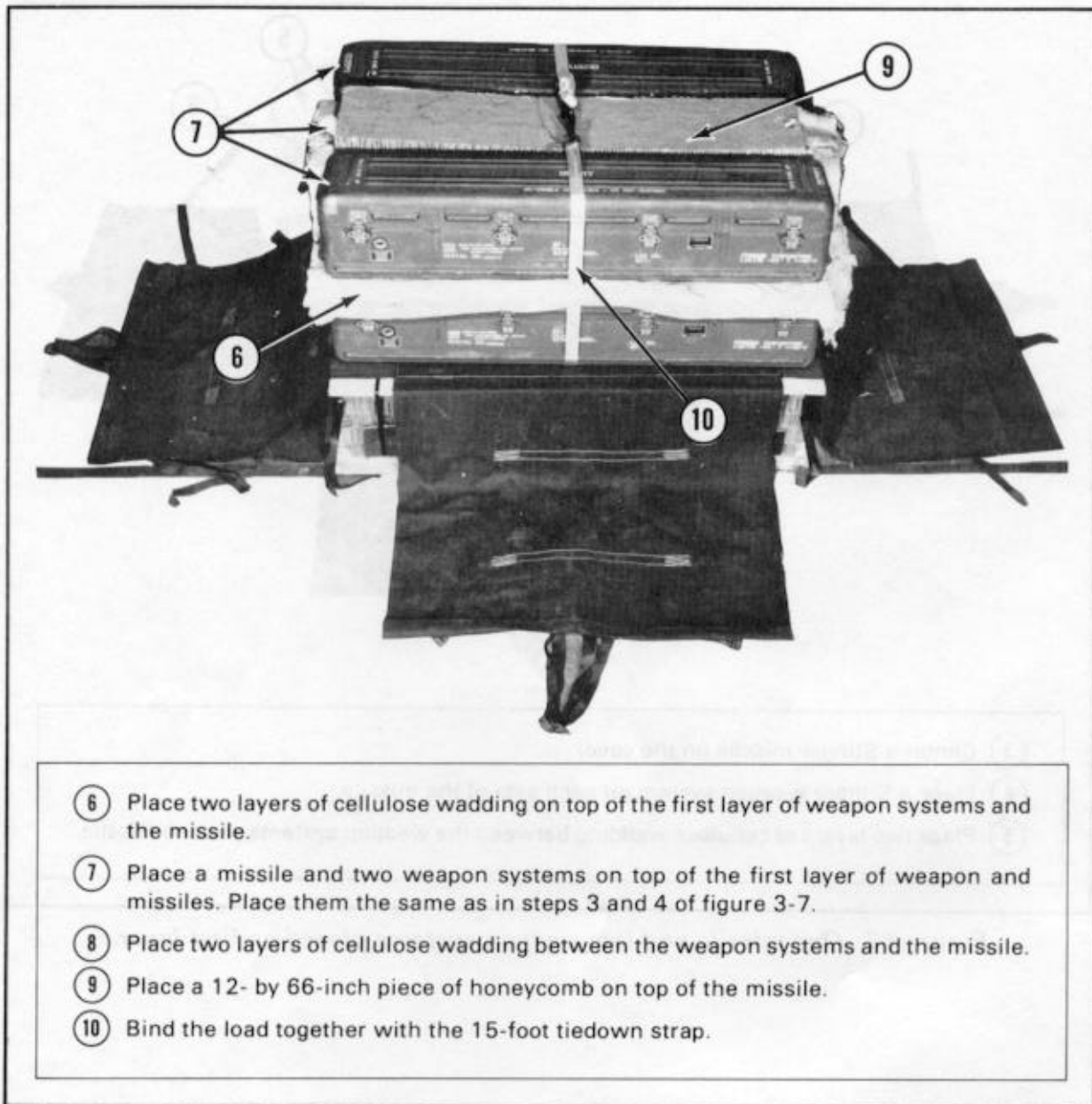
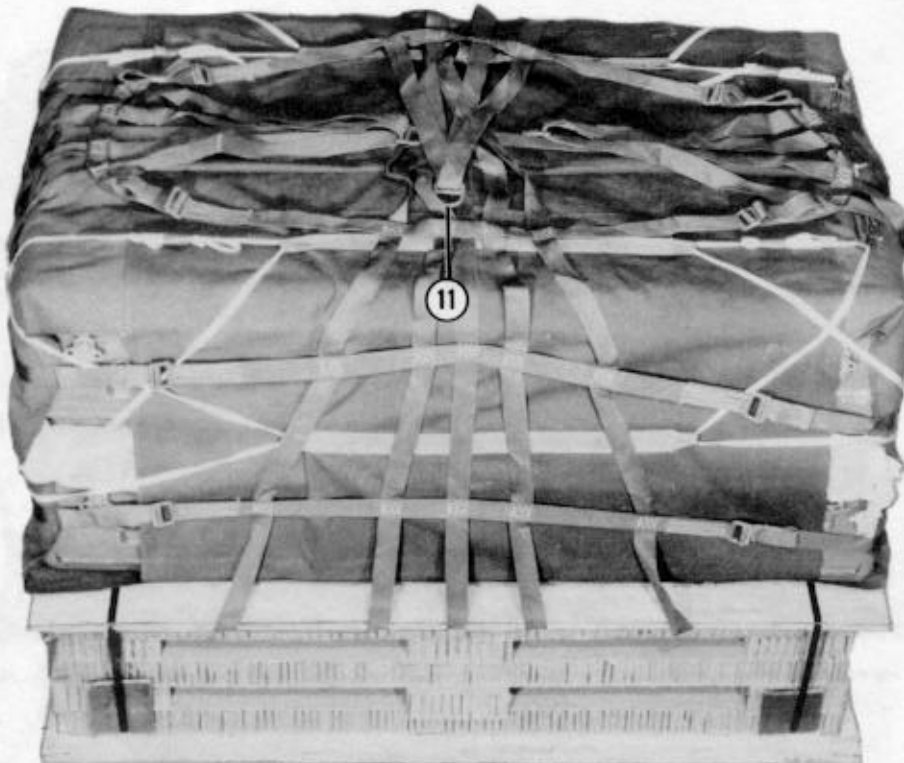

Figure 3-8. One missile and two weapon systems placed as second layer.



- ⑪ Close and secure the A-22 cargo bag according to FM 10-500-3/TO 13C7-1-11/ FMFM 7-47.

Figure 3-9. Cargo bag closed

3-4. Attaching Cargo Parachutes

Tape the suspension webs together, and attach a G-12E cargo parachute and a 68-inch pilot parachute according to FM 10-500-3/TO 13C7-1-11/FMFM 7-47.

3-5. Rigged Load Data

The rigged load data is given in Figure 3-10.

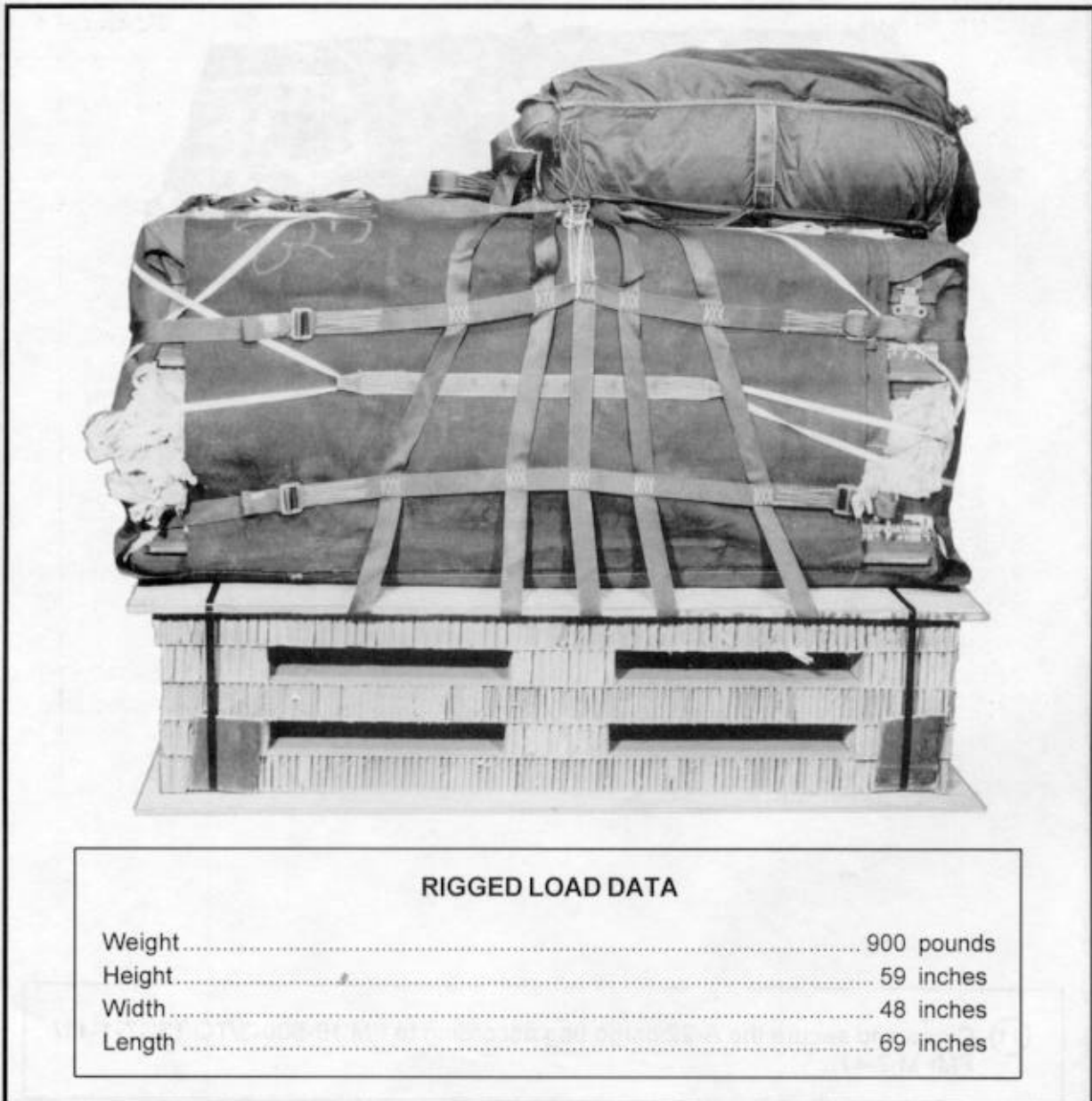

Figure 3-10. Stinger weapon systems and missiles rigged in an A-22 cargo bag for low-velocity airdrop

3-6. Equipment Required

The equipment required to rig this load is listed in Table 3-1.

Table 3-1. Equipment required for rigging Stinger weapon system and missiles in A-22 cargo bag

NATIONAL STOCK NUMBER	ITEM	QUANTITY
8040-00-273-8713	Adhesive, paste, 1-gal	As required
1670-00-587-3421	Bag, cargo, airdrop, type A-22	1
8135-00-664-6958	Cushioning material, packaging, cellulose wadding	As required
1670-00-753-3928	Pad, energy-dissipating, honeycomb 3- by 36- by 96-in: 6- by 62-in 8- by 44-in 12- by 66-in 31- by 44-in	3 (6) (6) (1) (2)
1670-01-065-3755	Parachute, cargo, G-12E	1
1670-00-216-7297	Parachute, pilot, 68-inch diameter	1
5530-00-128-4981	Plywood, 3/4- by 48- by 66-in	2
8135-00-283-0667	Strapping, steel, 5/8-in	60 ft
7510-00-266-5016	Tape, adhesive, 2-in	As required
8310-00-917-3945	Thread, cotton ticket, 5, 8/7 ply	As required
1670-00-937-0271	Tie-down assembly, 15-ft, 10,000-lb	1
8305-00-268-2411	Webbing, cotton, 1/4-in, 80-lb	As required
8305-00-082-5752	Webbing, nylon, tubular, 1/2-in	As required

CHAPTER 4

RIGGING STINGER WEAPON SYSTEMS AND MISSILES IN AN A-21 CARGO BAG FOR LOW-VELOCITY AIRDROP

4-1. Description of Load

This load can be dropped in three different combinations: two Stinger weapon systems and two Stinger missiles; four Stinger weapon systems; or four Stinger missiles rigged in an A-21 cargo bag with either a G-13 or a G-14 cargo parachute. The weight of the load will vary slightly depending on the combination used. For the C-130 and the C-5 aircraft, the rigged load can be dropped only as a ramp bundle. For C-141 aircraft, the rigged load may be

dropped as a door bundle or a ramp bundle.

4-2. Preparing Skid and Honeycomb

Prepare a two-layer plywood skid with honeycomb cushioning as shown in Figures 4-1 and 4-2.

NOTE: If load is to be dropped from a C-141 aircraft as a door bundle, omit steps 2 and 3 of Figure 4-1, and step 2 of Figure 4-2.

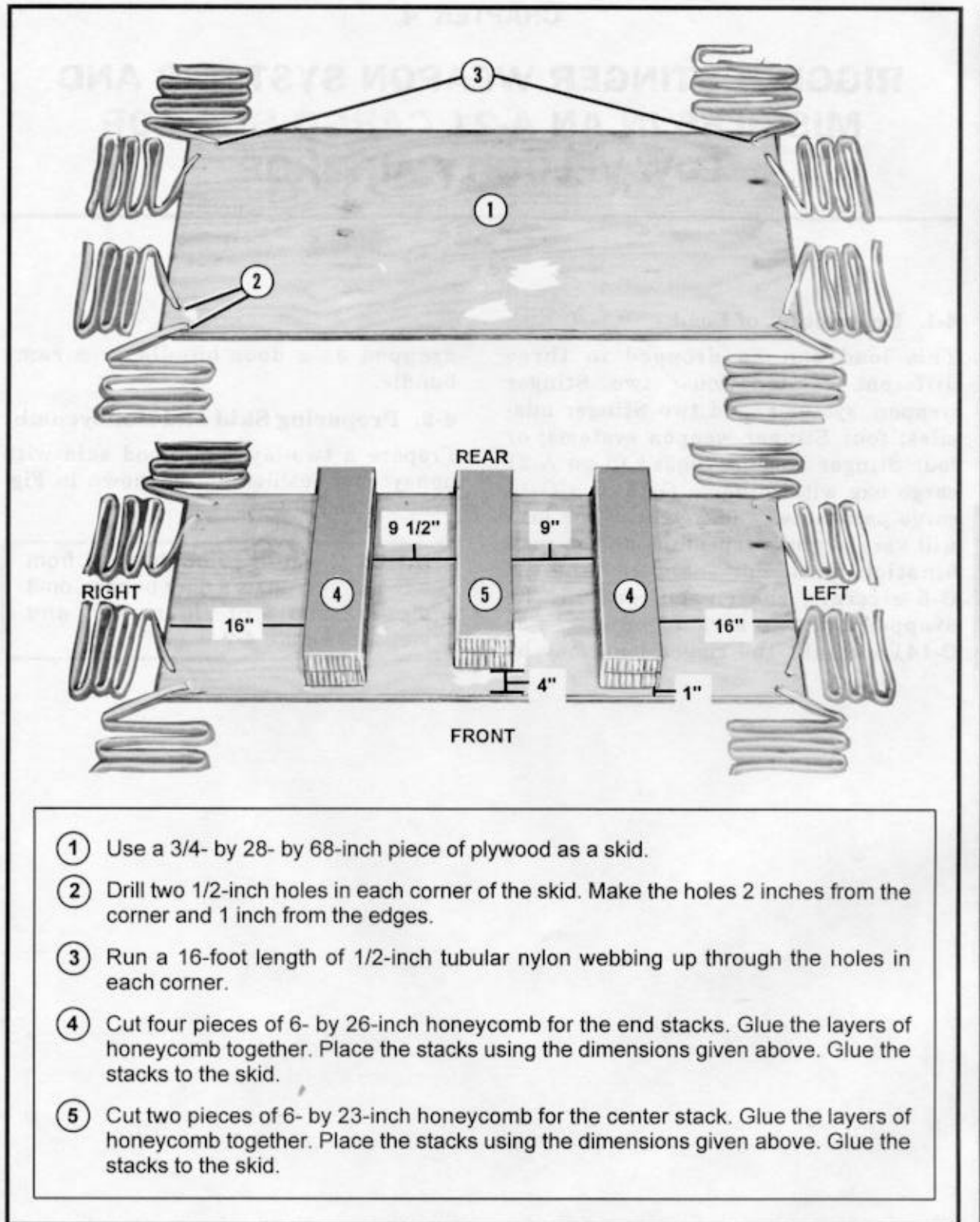

- ① Use a 3/4- by 28- by 68-inch piece of plywood as a skid.
- ② Drill two 1/2-inch holes in each corner of the skid. Make the holes 2 inches from the corner and 1 inch from the edges.
- ③ Run a 16-foot length of 1/2-inch tubular nylon webbing up through the holes in each corner.
- ④ Cut four pieces of 6- by 26-inch honeycomb for the end stacks. Glue the layers of honeycomb together. Place the stacks using the dimensions given above. Glue the stacks to the skid.
- ⑤ Cut two pieces of 6- by 23-inch honeycomb for the center stack. Glue the layers of honeycomb together. Place the stacks using the dimensions given above. Glue the stacks to the skid.

Figure 4-1. Bottom skid and honeycomb stacks prepared and placed

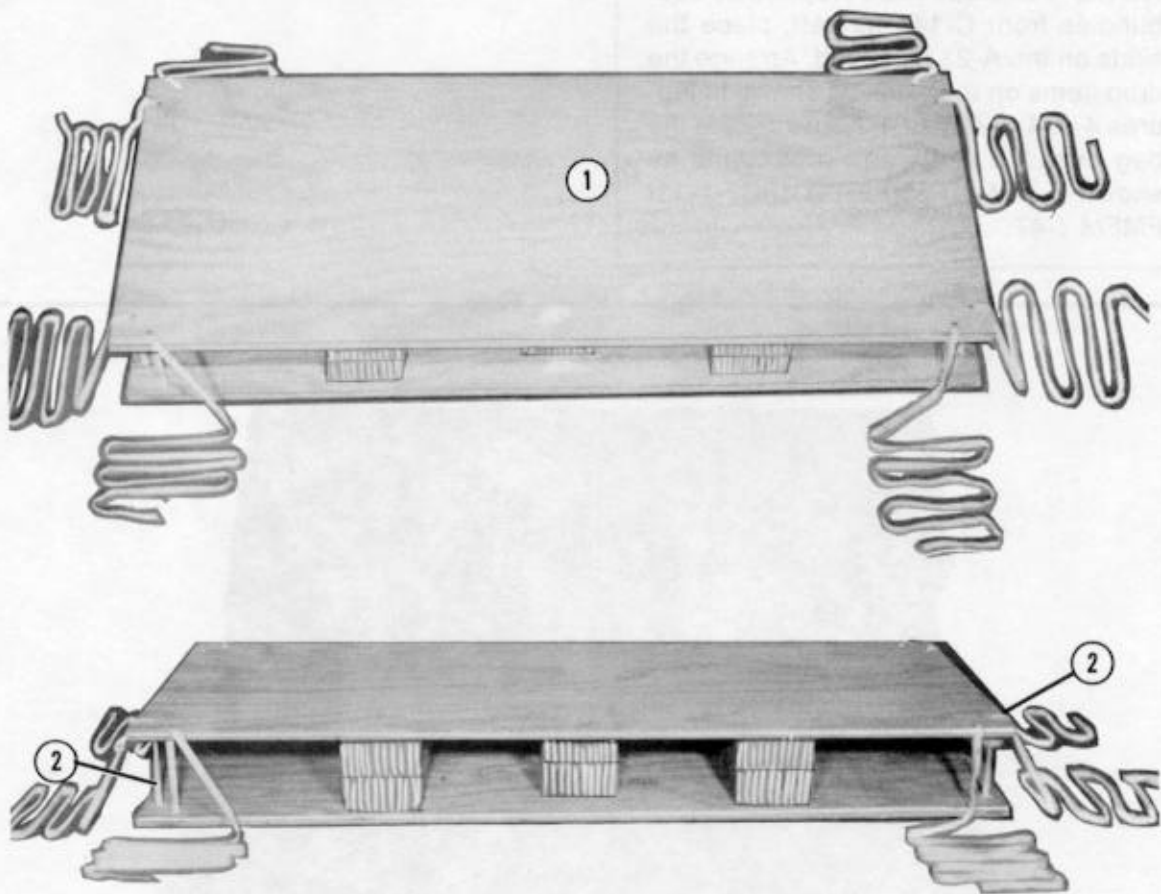

- ① Use a 3/4- by 28- by 68-inch piece of plywood as the top skid. Prepare the skid according to step 2 in Figure 4-1. Glue it to the honeycomb stacks.
- ② Run the webbing from the corner holes in the bottom skid up through the corresponding corner holes in the top skid.

Figure 4-2. Top skid prepared and glued to honeycomb

4-3. Rigging A-21 Cargo Bag

Follow the procedures in subparagraphs a, b, or c below, depending on the load configuration.

NOTE: For loads to be dropped as door bundles from C-141 aircraft, place the skids on the A-21 scuff pad. Arrange the drop items on the skids as shown in Figures 4-4, 4-5, 4-6, or 4-7, and secure the bag over the skids and drop items as shown in FM 10-500-3/TO 13C7-1-11/ FMFM 7-47.

a. Two Weapon Systems and Two Missiles. Position and secure two weapon systems and two missiles as shown in Figures 4-3 through 4-5.

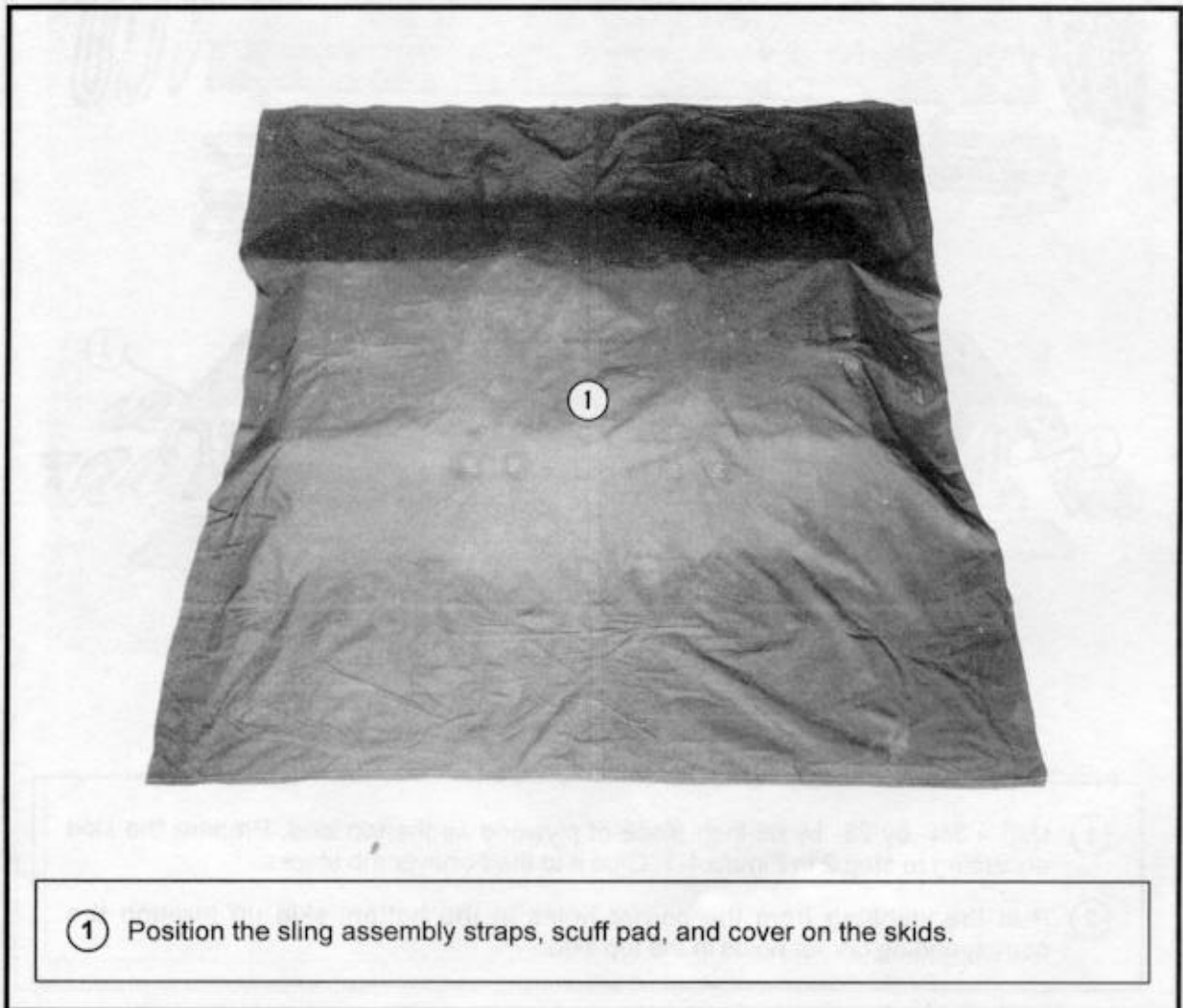
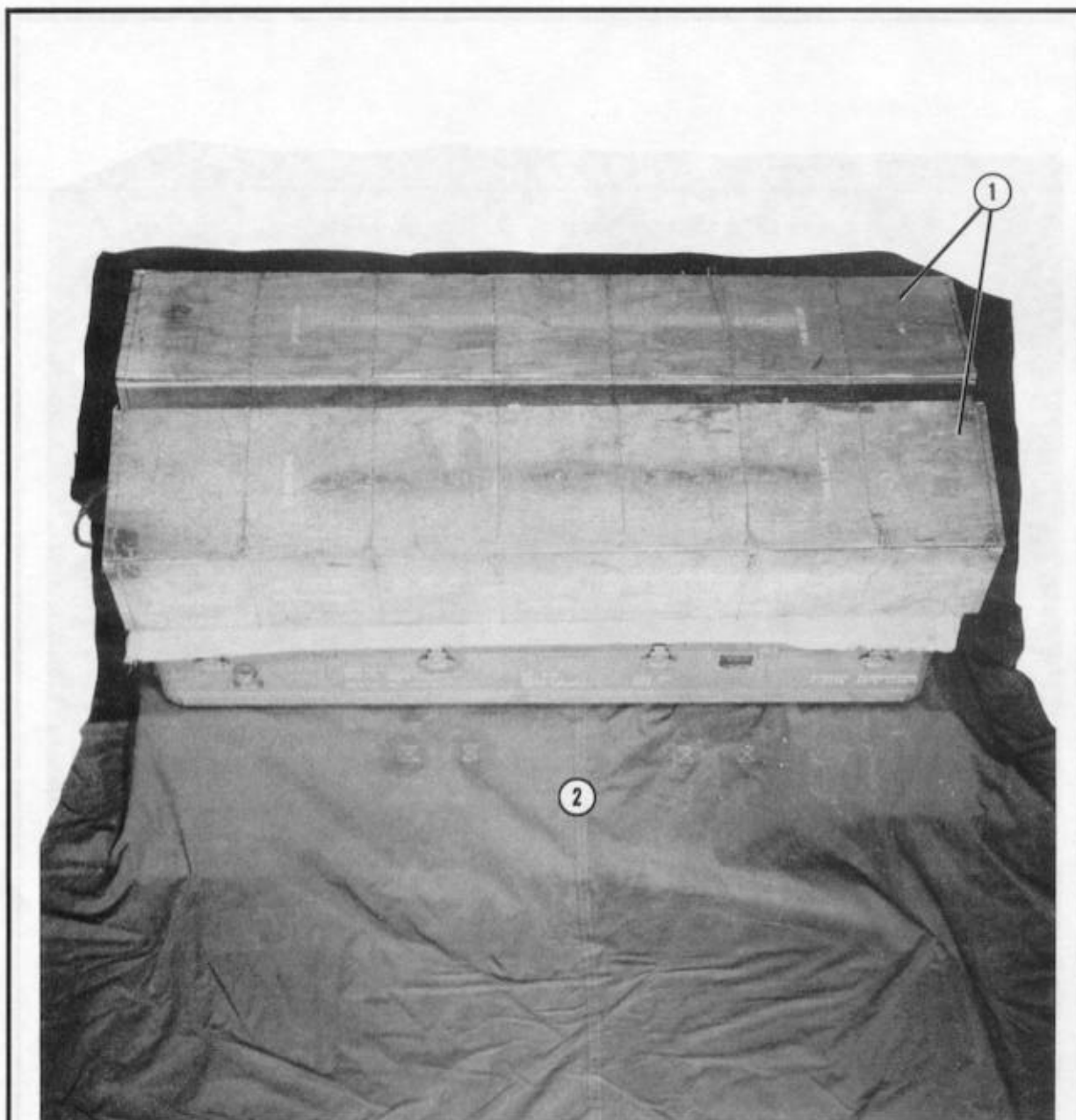

Figure 4-3. A-21 sling assembly and cover placed



- ① Center the weapon systems on the cover. Put two layers of cellulose wadding between the systems.
- ② Put two layers of cellulose wadding on top of the weapon systems (not shown).

Figure 4-4. Two weapon systems placed on A-21 cargo bag



- ① Set two missiles on top of the cellulose wadding and the weapon systems.
- ② Close the A-21 cargo bag as outlined in FM 10-500-3/TO 13C7-1-11/FMFM 7-47.

Figure 4-5. Two missiles placed on A-21 cargo bag cover

b. Four Weapon Systems. Position and secure four weapon systems as shown in Figure 4-6.

c. Four Missiles. Position and secure four missiles as shown in Figure 4-7.

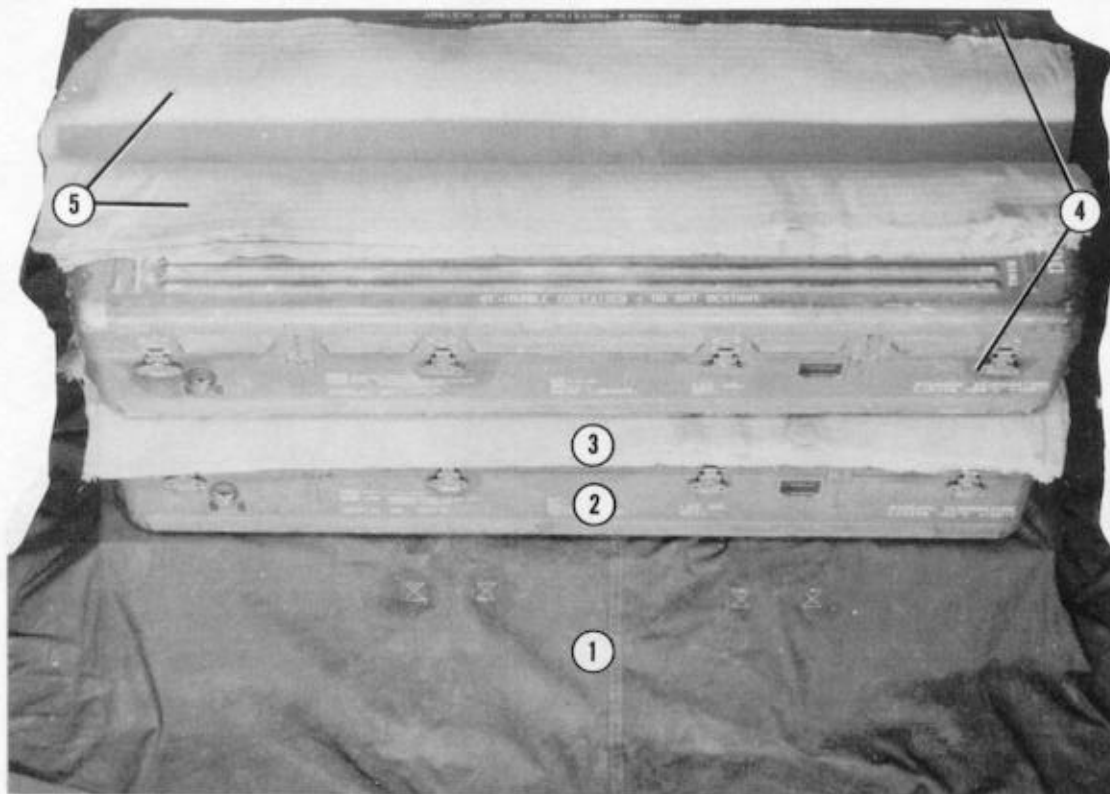

- ① Lay the A-21 cargo bag over the top skid.
- ② Center two weapon systems on the cover, and pad between the two systems with two layers of cellulose wadding as shown in Figure 4-4.
- ③ Put two layers of cellulose wadding on top of the weapon systems.
- ④ Align two more weapon systems on top of the first set of weapon systems.
- ⑤ Put two layers of cellulose wadding between the weapon systems in the top set as in step 2 above.
- ⑥ Close the A-21 cargo bag as outlined in FM 10-500-3/TO 13C7-1-11/FMFM 7-47 (not shown).

Figure 4-6. Four weapon systems placed on A-21 cargo bag cover

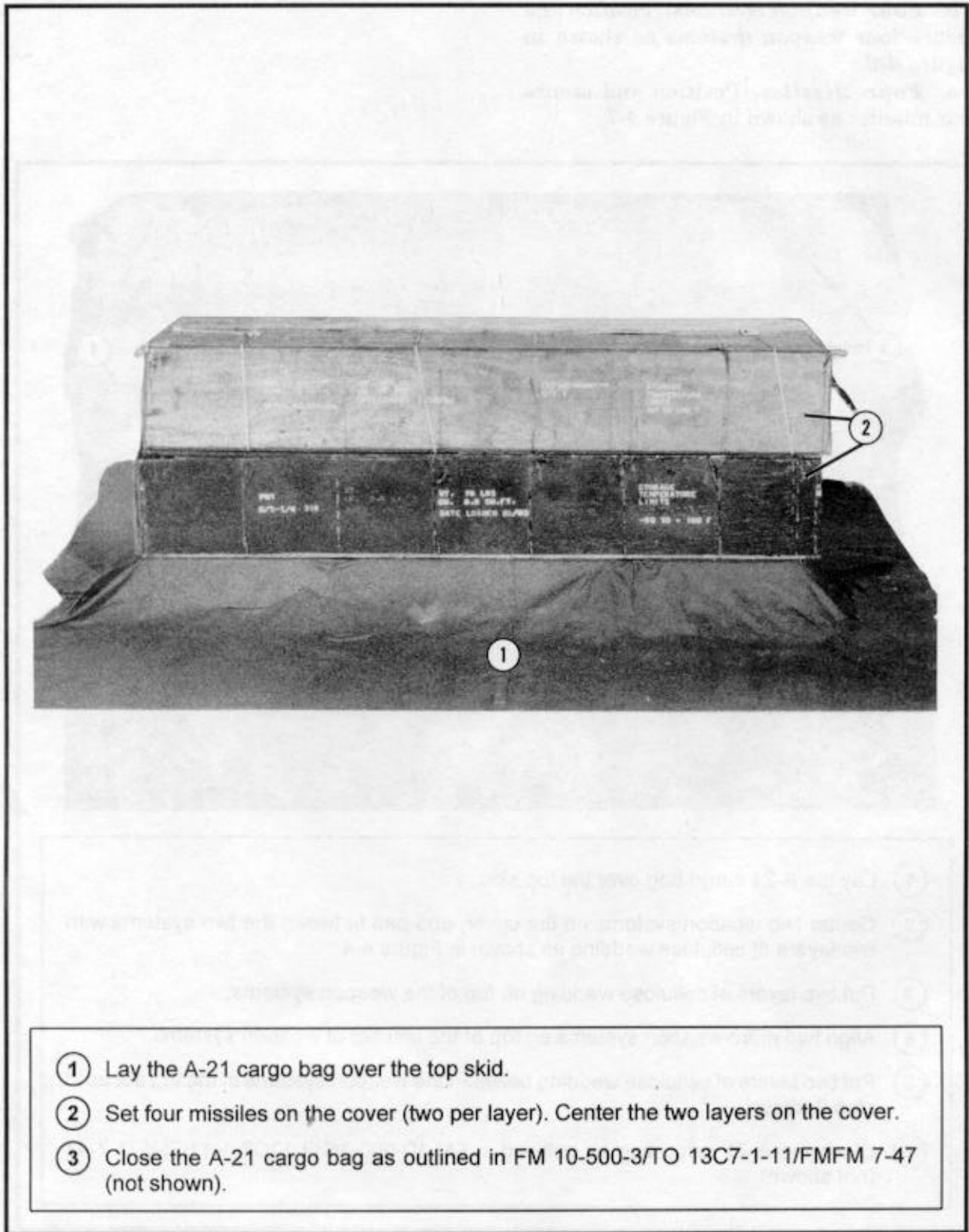

Figure 4-7. Four missiles placed on A-21 cargo bag cover

4-4. Securing Load to Skid

Secure the rigged A-21 cargo bag to the skid as shown in Figure 4-8.

4-5. Attaching Cargo Parachute

Attach one G-13 or one G-14 cargo parachute to the A-21 cargo bag as outlined in FM 10-500-3/TO 13C7-1-11/FMFM 7-47.

4-6. Rigged Load Data

The rigged load data is given in Figure 4-9.

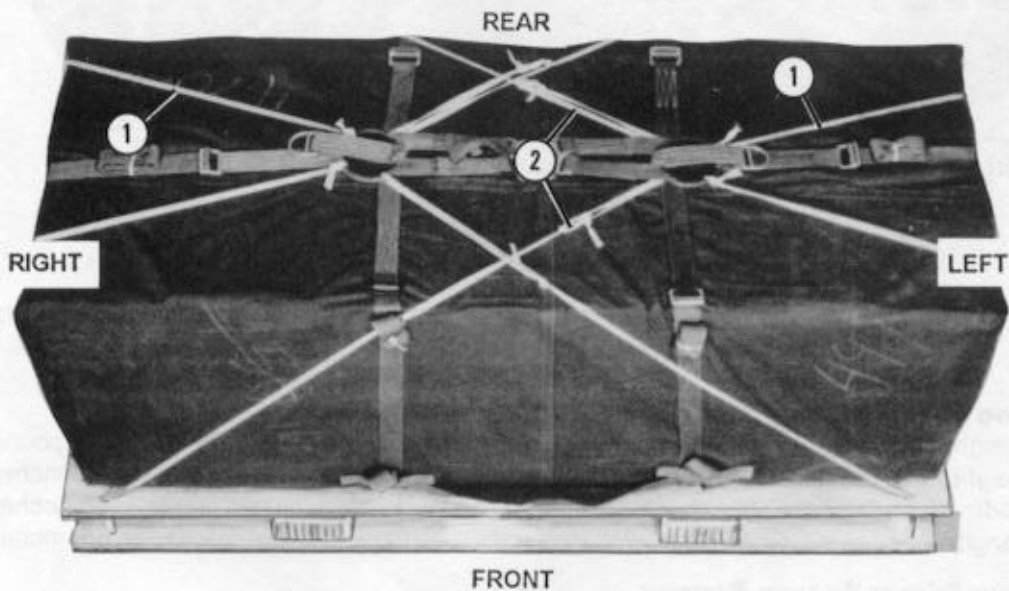

- ① Tie the left and right ends of the 1/2-inch tubular nylon webbing to the nearer O-ring.
- ② Cross the front and rear lengths of 1/2-inch tubular nylon webbing, and tie the ends to the opposite O-ring.

Figure 4-8. Rigged A-21 cargo bag secured to skid

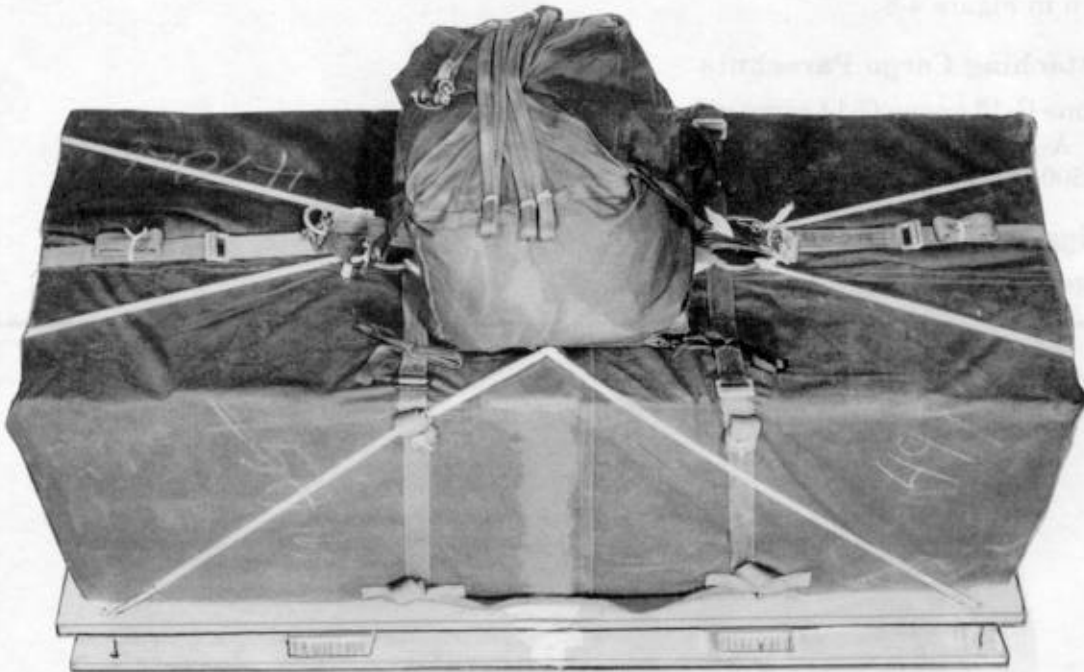

RIGGED LOAD DATA

A. Two Stinger Weapon Systems and Two Stinger Missiles	
Weight	465 pounds
Height	47 inches
Width	28 inches
Length	68 inches
B. Four Stinger Weapon Systems	
Weight	500 pounds
Height	48 inches
Width	28 inches
Length	68 inches
C. Four Stinger Missiles	
Weight	435 pounds
Height	48 inches
Width	28 inches
Length	68 inches

Figure 4-9. Rigged load data

4-7. Equipment Required

The equipment required for rigging the Stinger weapon systems and missiles in an A-21 cargo bag is listed in table 4-1.

Table 4-1. Equipment required for rigging Stinger weapon systems and missiles in an A-21 cargo bag for low-velocity airdrop.

NATIONAL STOCK NUMBER	ITEM	QUANTITY
8040-00-273-8713	Adhesive, paste, 1-gal	As required
1670-00-242-9173	Bag, cargo, A-21	1
8135-00-664-6958	Cushioning material, packaging, cellulose wadding	As required
1670-00-753-3928	Pad, energy-dissipating, honeycomb,	
	3- by 36- by 96-in:	2 sheets
	6- by 26-in	(6)
1670-00-984-3535	Parachute, cargo, G-13 or	1
1670-00-999-2658	Parachute, cargo, G-14	1
5530-00-128-4981	Plywood, 3/4-in:	2 sheets
	28- by 69-in	(2)

CHAPTER 5

RIGGING 1/4-TON TRUCK AND TRAILER WITH STINGER WEAPON SYSTEMS AND MISSILES ON A TYPE V PLATFORM

Section I LOW-VELOCITY AIRDROP

5-1. Description of Load

The M151, 1/4-ton utility truck and the M416, 1/4-ton cargo trailer loaded with the Stinger weapon systems and missiles and the accompanying load are rigged on a 16-foot, type V platform. The load requires either two G-11A or two G-11B cargo parachutes for a low-velocity airdrop from a C-130 or C-141 aircraft. The accompanying load shown in this section is six boxes of ammunition on the platform and three boxes of ammunition in the truck.

5-2. Preparing Platform

Prepare the platform as given below.

a. Inspecting Platform. Inspect, or assemble and inspect, the 16-foot, type V platform as outlined in TM 10-1670-268-20&P/TO 13C7-52-22.

b. Installing Multipurpose Links. Install a multipurpose link on the front and rear of each rail as shown in Figure 5-1.

c. Attaching and Numbering Clevises. Bolt 28 tiedown clevises to the side rail bushings and multipurpose links according to FM 10-500/TO 13C7-1-5. Number the clevises as shown in Figure 5-1.

NOTE: 1. The nose bumper may or may not be installed.

2. The measurements given in this section are from the front edge of the platform, NOT from the front edge of the nose bumper.

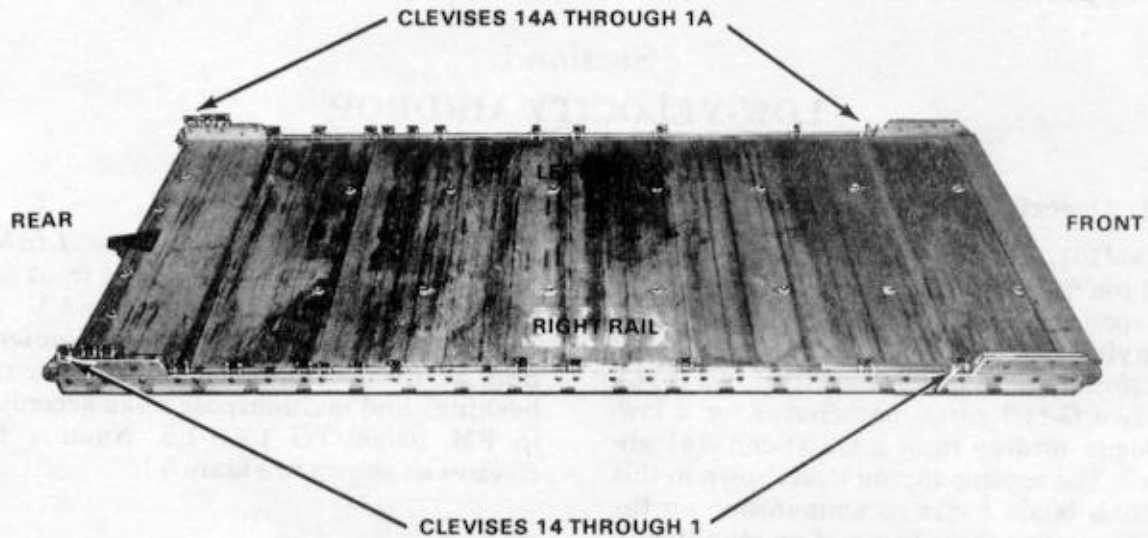

Step:

1. Start at bushing 1 behind the front multipurpose link. Attach a clevis on both rails to bushings 1, 4, 10, 13, 15, 19, 20, 21, 22, 24, and 26.
2. Attach a clevis to rear multipurpose link bushings 2, 3, and 4 on each side.
3. Start at the front of the platform. Number the clevises bolted to the right rail 1 through 14 and those bolted to the left rail 1A through 14A as outlined in FM 10-500/TO 13C7-1-5.

Figure 5-1. Platform prepared

5-3. Building and Placing Honeycomb Stacks

Build and place honeycomb stacks as shown in Figures 5-2, 5-3, and 5-4.

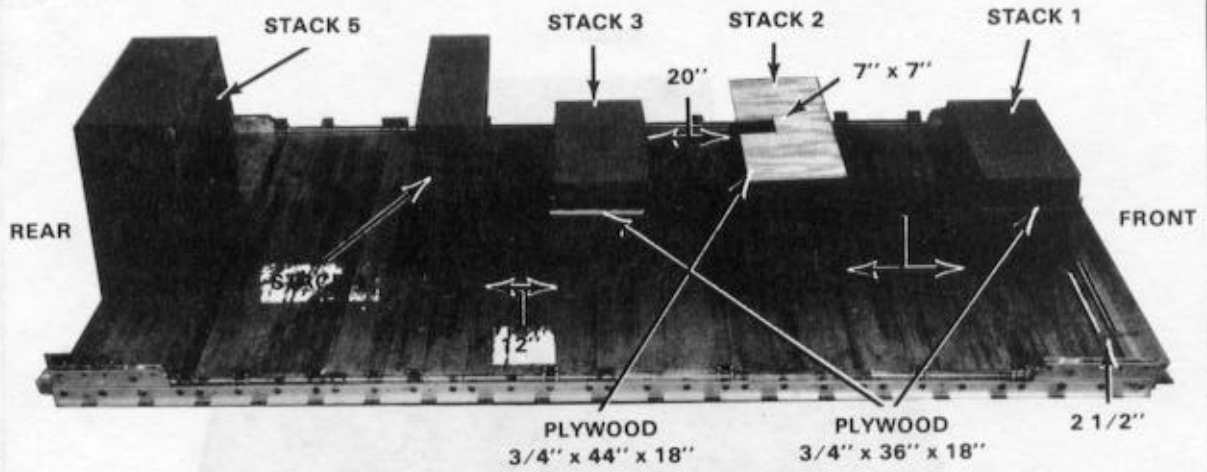

Stack Number	Pieces	Width (inches)	Length (inches)	Material	Instructions
1	7	36	18	Honeycomb	Use honeycomb as the base of the stack. Center stack 2 1/2 inches from front edge of the platform.
	1	36	18	3/4-inch plywood	Place plywood under second layer of honeycomb from the top.
2	8	18	12	Honeycomb	Center four pieces of honeycomb on each side of the platform 25 inches from stack 1.
	1	44	6	Honeycomb	Use honeycomb as bridge.
	4	12	6	Honeycomb	Place one piece of honeycomb on each side of the bridge to level stack.
	6	6	18	Honeycomb	Center three pieces of honeycomb on each side stack.
3	1	44	18	3/4-inch plywood	Place plywood, with a 7- by 7-inch cutout centered at the rear, on top of the honeycomb.
	7	36	18	Honeycomb	Center stack 20 inches from stack 2.
4	1	36	18	3/4-inch plywood	Place plywood under second layer of honeycomb from the top.
	12	42	12	Honeycomb	Center stack 12 inches from stack 3.
5	12	42	18	Honeycomb	Center stack flush with the rear of the platform.

Figure 5-2. Honeycomb positioned

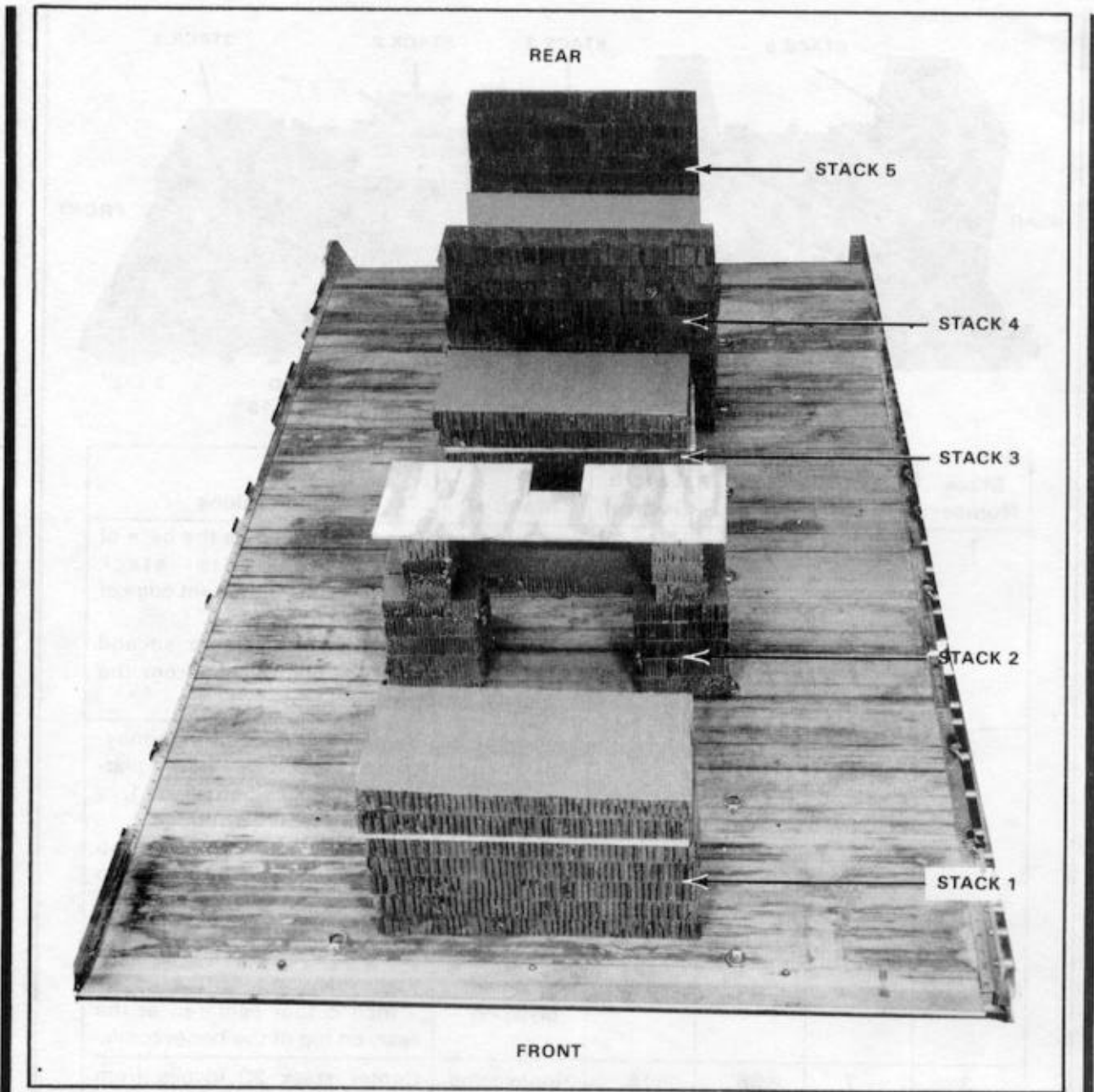

Figure 5-3. Front view of honeycomb stacks positioned on platform

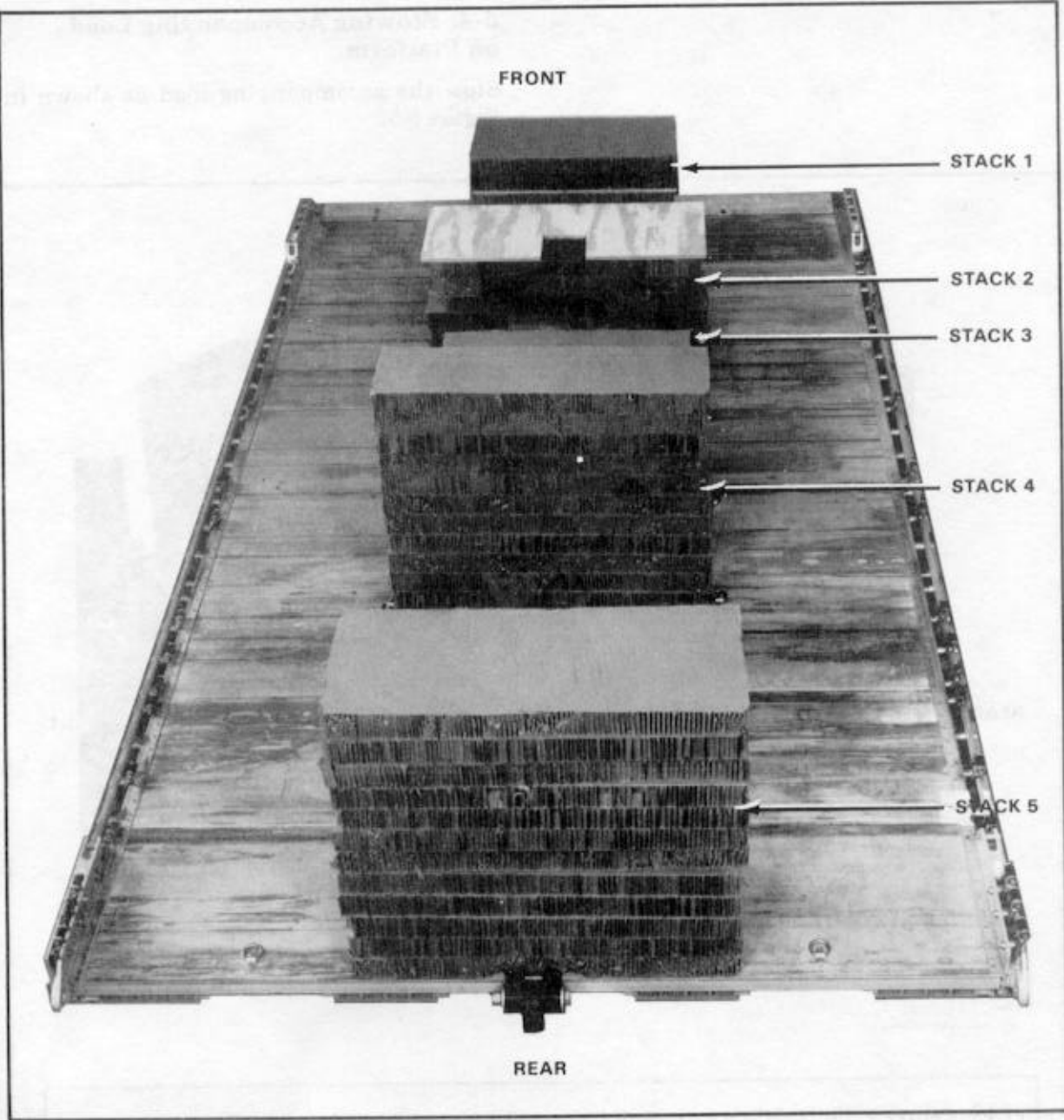
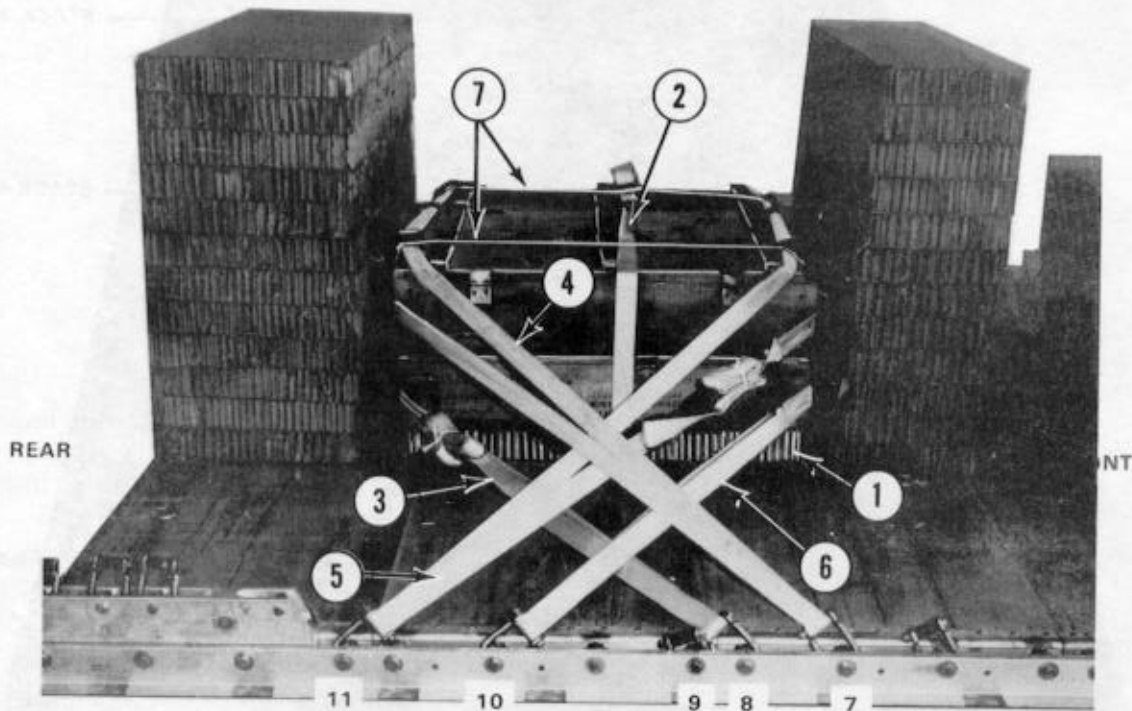

Figure 5-4. Rear view of honeycomb stacks positioned on platform

5-4. Stowing Accompanying Load on Platform

Stow the accompanying load as shown in Figure 5-5.



- ① Center a 36- by 36-inch piece of honeycomb between stacks 4 and 5.
- ② Lay a 15-foot tiedown strap across the honeycomb. Set six boxes of ammunition on the honeycomb in a two-layer stack. Run the strap around the boxes, and secure the ends with a D-ring and a load binder.
- ③ Form a 30-foot lashing according to FM 10-500/TO 13C7-1-5. Pass the lashing from clevis 8, around the rear of the lower boxes, and through clevis 8A. Secure the lashing with a D-ring and a load binder.

Figure 5-5. Accompanying load stowed

- ④ Form a 30-foot lashing according to FM 10-500/TO 13C7-1-5. Pass the lashing from clevis 7, around the rear of the top boxes, and through clevis 7A. Secure the lashing with a D-ring and a load binder.
- ⑤ Form a 30-foot lashing according to FM 10-500/TO 13C7-1-5. Pass the lashing from clevis 11, around the front of the top boxes, and through clevis 11A. Secure the lashing with a D-ring and a load binder.
- ⑥ Form a 30-foot lashing according to FM 10-500/TO 13C7-1-5. Pass the lashing from clevis 10, around the front lower boxes, and through clevis 10A. Secure the lashing with a D-ring and a load binder.
- ⑦ Safety the load with two ties of type III nylon cord. Run the ties over the top of the boxes from the front top lashing to the rear top lashing.

Figure 5-5. Accompanying load stowed (continued)

5-5. Preparing Truck

Prepare the M151, 1/4-ton truck using the information given below. The truck may have several specialized kits issued with it. Since all of the information provided here may not apply to the truck you are rigging, use only that information which applies. Prepare the truck as follows:

- Remove the doors, side curtains, top cover, and rear seat. These items will be stowed later.
- Make sure the front seats are secured. If the seat locking pins are not available, tie the seats down with type III nylon cord.

- Make sure the fuel tank is not less than 1/2 or more than 3/4 full.

- Place the pioneer tools in their racks, and secure the tools with their tiedown straps. If the tiedown straps cannot be used, tie the tools in place with type III nylon cord.

- Make sure the battery and battery compartment comply with AFR 71-4/TM 38-250, and prepare them according to FM 10-500/TO 13C7-1-5 and AFR 71-4/TM 38-250.

- Prepare the truck as shown in Figures 5-6 through 5-9.

NOTE: If the windshield is removed and will not be rigged as part of this load, delete steps 1 through 4.

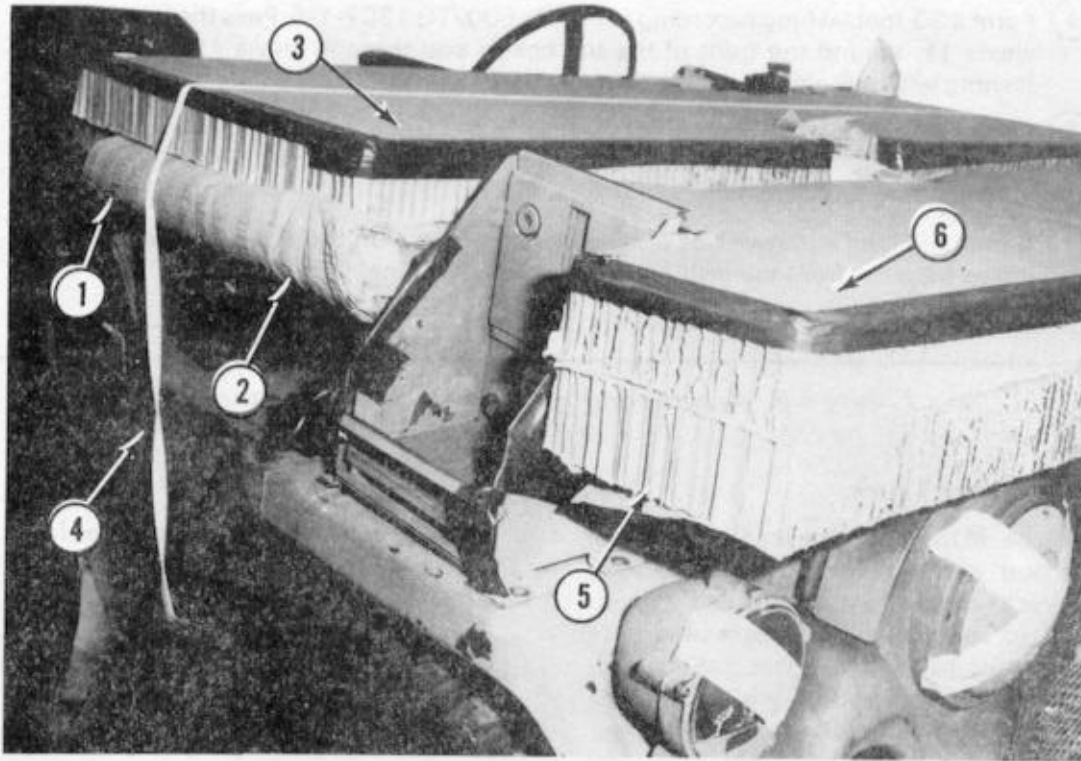

- ① Wrap the windshield with several layers of cellulose wadding. Tape the wadding in place.
- ② Fold the windshield down, and fasten the retaining strap to the hood bracket. If the strap is missing, tie the windshield down with type III nylon cord (not shown).
- ③ Use a 24- by 61-inch piece of honeycomb, and make a 6- by 9-inch cutout for the wiper motor and a 4- by 4-inch cutout for the rearview mirror. Place the honeycomb on the windshield. Tape the top edges of the honeycomb.
- ④ Pass a length of 1/2-inch tubular nylon webbing over the honeycomb from the left mainframe to the right mainframe. Tie the webbing in place.
- ⑤ Lay an 18- by 61-inch piece of honeycomb on the hood of the truck. Make cutouts to fit around the chemical detector bracket.
- ⑥ Lay an 18- by 61-inch piece of honeycomb on the honeycomb positioned in step 5. Tape the top edges of the honeycomb.

Figure 5-6. Windshield padded and secured

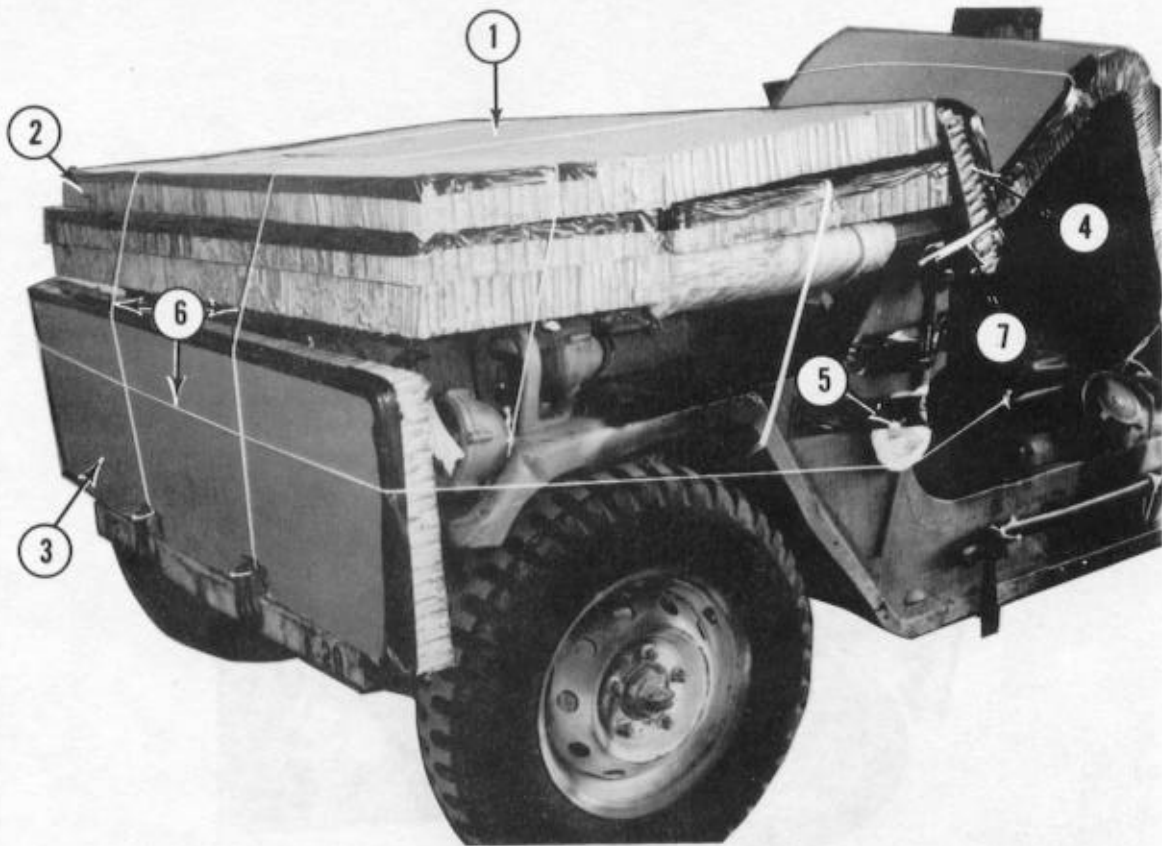

- ① Make a 6- by 9-inch cutout in an 18- by 61-inch piece of honeycomb to match the 6- by 9-inch cutout in Figure 5-6, step 3. Lay the honeycomb on the honeycomb placed in Figure 5-6, step 3.
- ② Lay a 24- by 61-inch piece of honeycomb on the honeycomb placed in Figure 5-6, steps 5 and 6, if the honeycomb needs to be leveled. Tape the top edges of the honeycomb.
- ③ Make two 4- by 7-inch cutouts in an 18- by 61-inch piece of honeycomb for the front lifting shackles. Place the honeycomb on the front bumper.
- ④ Set a 12- by 61-inch piece of honeycomb on the steering column and against the dash. Tape the edges of the honeycomb.
- ⑤ Pad the side mirror with cellulose wadding, turn the mirror down against the body, and tape the mirror in place.
- ⑥ Tie the honeycomb in place with lengths of type III nylon cord.
- ⑦ Tie the steering wheel to the left windshield hinge bracket with a length of doubled type III nylon cord or 1/2-inch tubular nylon webbing.

Figure 5-7. Mirror padded and honeycomb and steering wheel secured

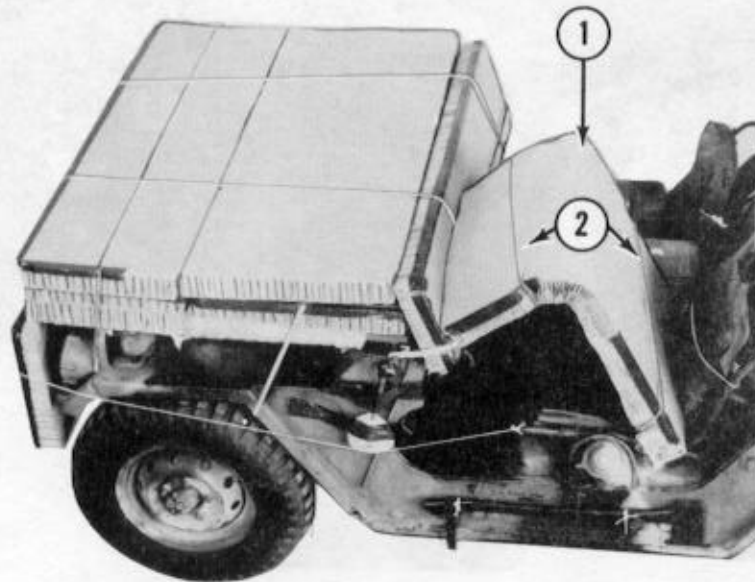

- ① Place the 36-inch side of a 36- by 47-inch piece of honeycomb (steering wheel protector) against the driver's seat and the steering wheel. Make several knife cuts across the honeycomb on the underside at the top of the steering wheel to make the honeycomb bend. Fold the top of the honeycomb down against the steering wheel column and the honeycomb on the dash.
- ② Tie the steering wheel protector in place with two lengths of type III nylon cord.

NOTE: Tape the edges of the honeycomb where it touches the type III nylon cord.

Figure 5-8. Steering wheel protector positioned and secured

CAUTION: The truck must be rigged with an accompanying load. The load must weigh at least 250 pounds but no more than 500 pounds.

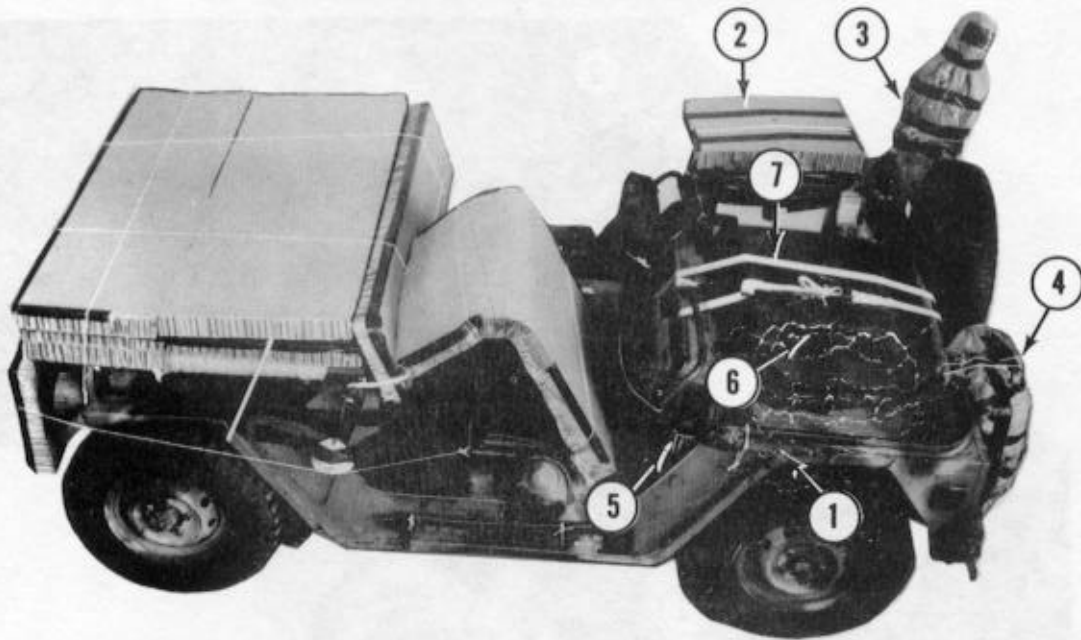

- ① Lower the top bows. Pad the hinges with cellulose wadding, and tape the wadding in place. Tie the bows in place with type III nylon cord.
- ② Cover each radio or radio mount with a 12- by 16-inch piece of honeycomb, and tie it in place with type III nylon cord.
- ③ Pad the antenna mount brackets with cellulose wadding. Tape the wadding in place. Pad and tape the antenna sections with cellulose wadding, and tie them between the seats with type III nylon cord.
- ④ Fill the gasoline can to 1 inch below the filler neck threads. Set the can on the rear bumper. Cover the can with cellulose wadding. Secure the can with the retainer strap, or tie it with type III nylon cord.
- ⑤ Place a 32- by 36-inch piece of honeycomb on the floor of the truck. Lay a 15-foot tiedown strap across the honeycomb, and set three ammunition boxes on the honeycomb. Bind the strap together with a D-ring and a load binder.
- ⑥ Set the doors, side curtains, and top cover on top of the boxes.
- ⑦ Run another 15-foot tiedown strap under the towing pintle, over the ammunition boxes, and through the frames of both front seats. Bind the ends together with a D-ring and a load binder.

Figure 5-9. Truck rear prepared

5-6. Preparing Trailer

Prepare the trailer as shown in Figure 5-10.

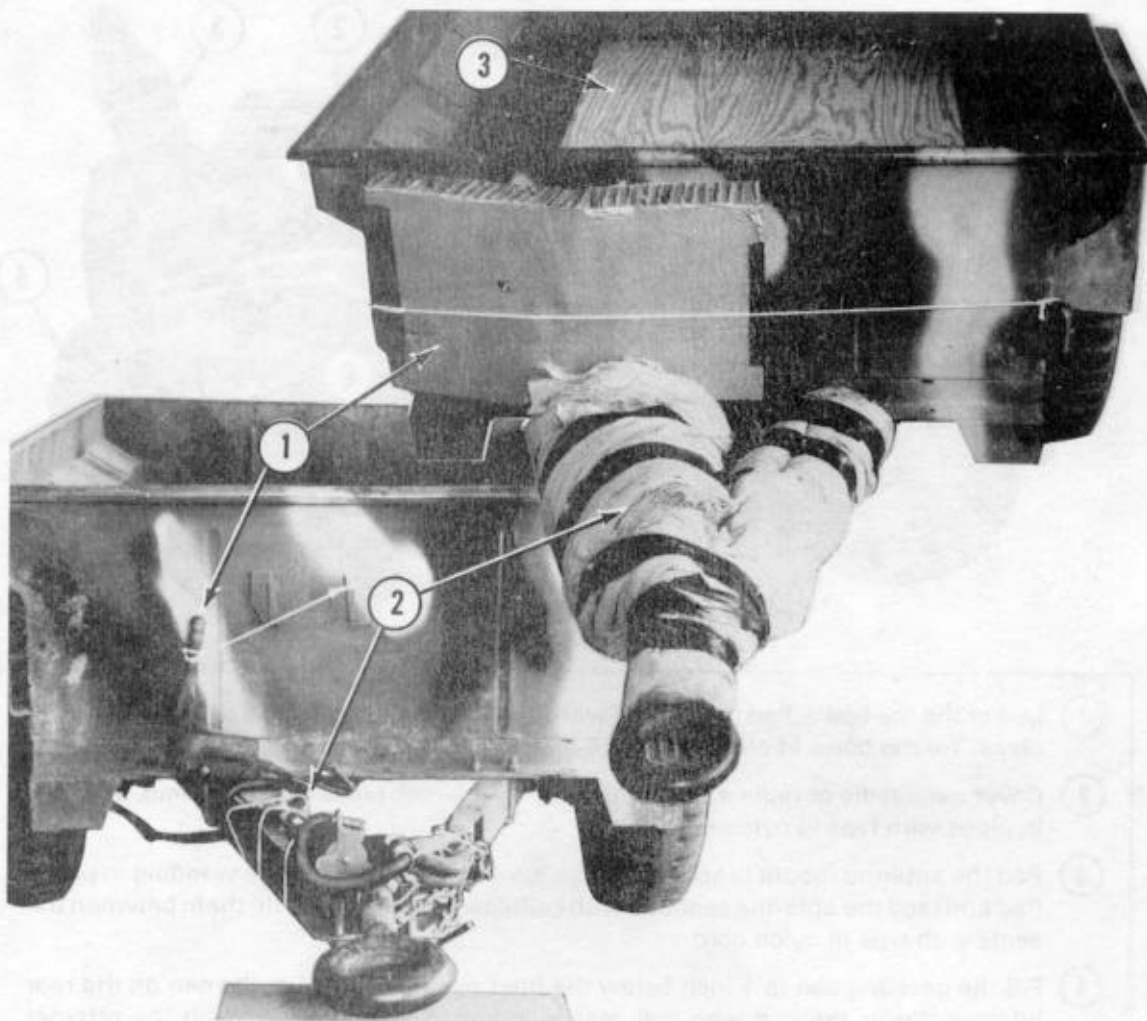

- ① Remove the trailer cover. Tie the hand brake in the unlocked position with type III nylon cord. Cover the brake with a 14- by 24-inch piece of honeycomb. Tie it in place with type III nylon cord. Tape the edges of the honeycomb where it touches the type III nylon cord.
- ② Fold the intervehicular cable, and tie the cable and chains to the drawbar with type III nylon cord. Pad the drawbar with cellulose wadding, and tape the wadding in place.
- ③ Place a 3/4- by 36- by 70-inch piece of plywood in the bed of the trailer.

Figure 5-10. Trailer prepared

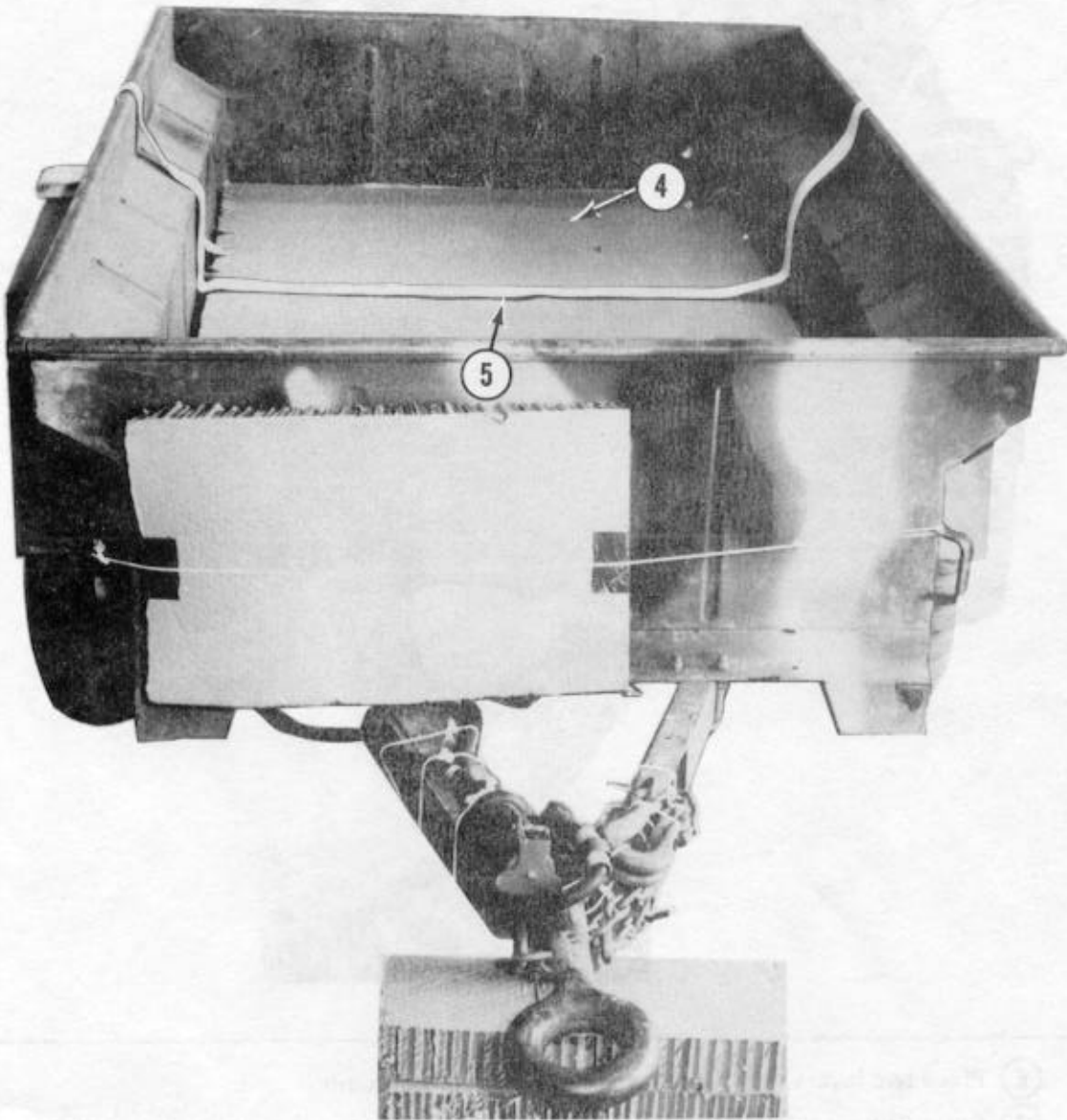

- ④ Lay two 36- by 40-inch pieces of honeycomb side by side on the plywood.
- ⑤ Lay a 15-foot tiedown strap on the honeycomb as shown.

Figure 5-10. Trailer prepared (continued)

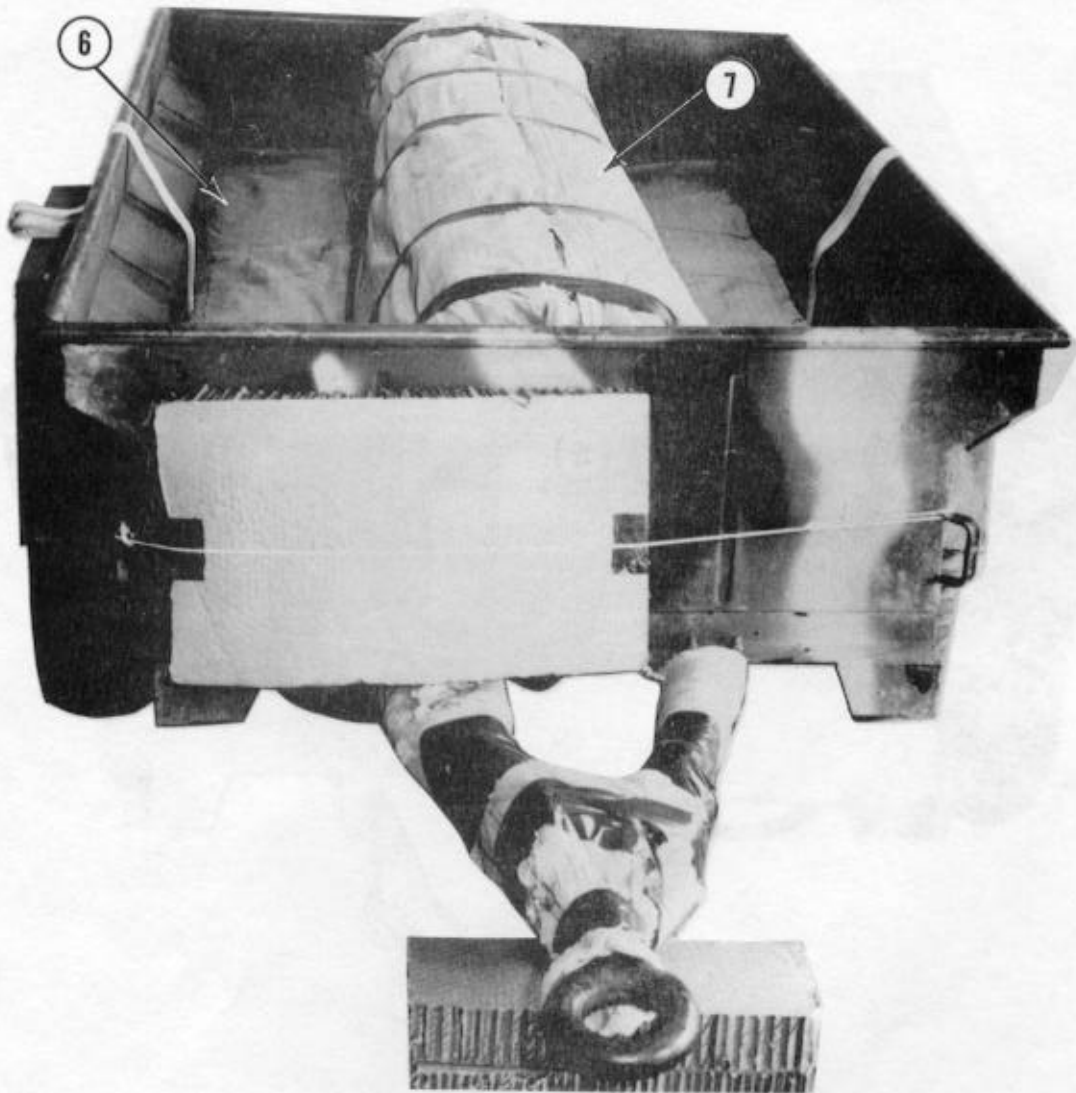

- ⑥ Place two layers of cellulose wadding on the honeycomb.
- ⑦ Set a Stinger missile in the center of the trailer. Cover the missile with cellulose wadding, and tape the wadding in place.

Figure 5-10. Trailer prepared (continued)

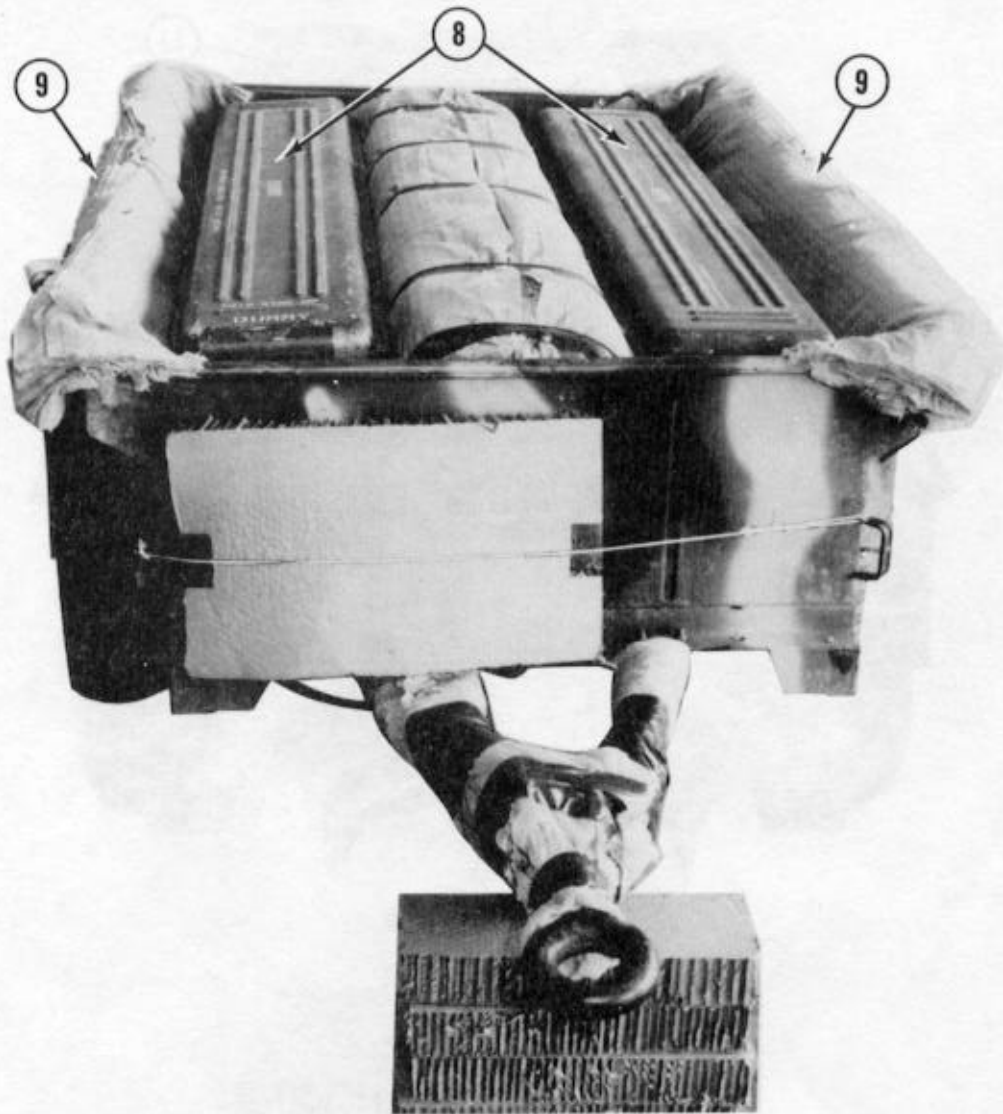

- ⑧ Set a Stinger weapon system on each side of the missile.
- ⑨ Place two layers of cellulose wadding around each weapon system.

Figure 5-10. Trailer prepared (continued)

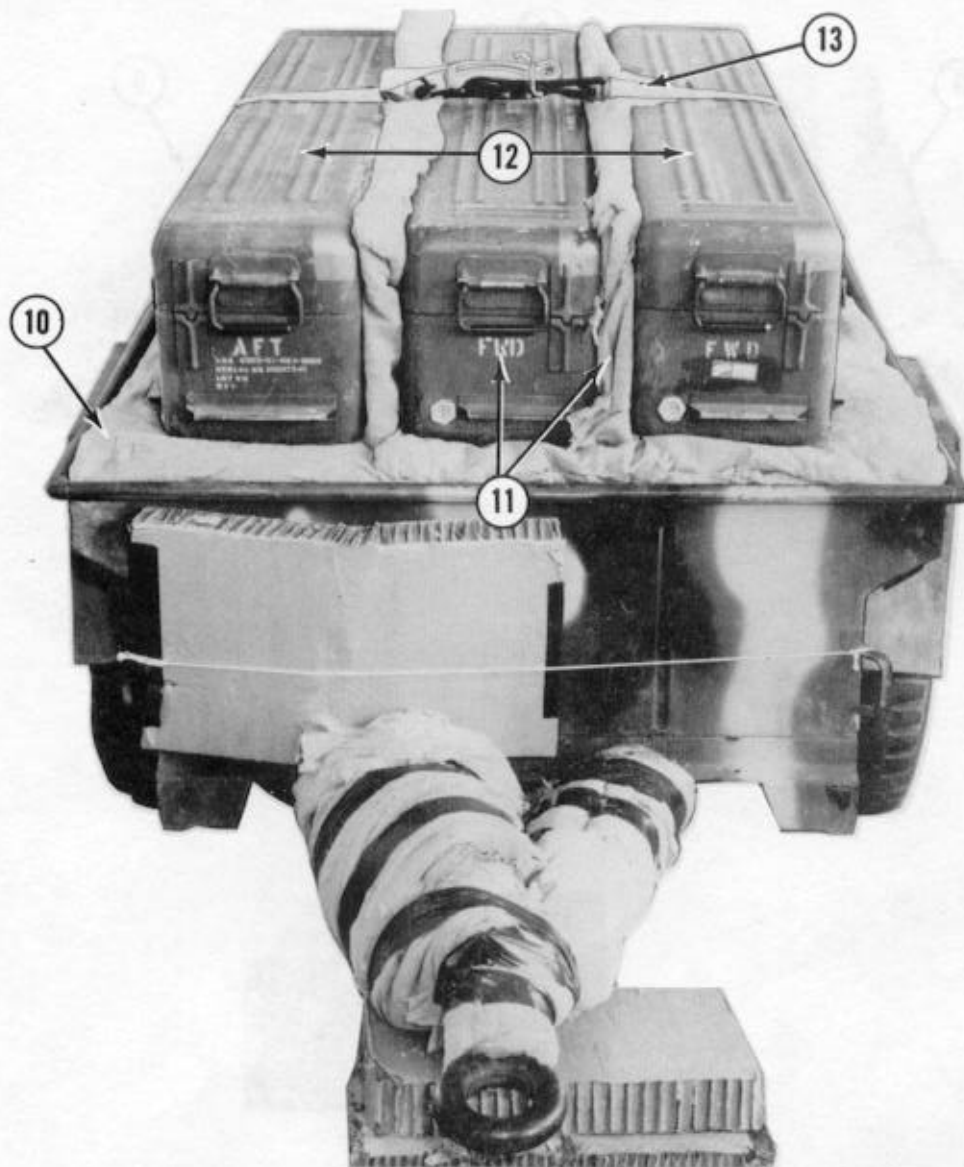

- ⑩ Cover the weapon systems with cellulose wadding. Push the wadding down between the ends of the trailer and the weapon systems.
- ⑪ Set a missile on top of the missile placed in step 7. Place cellulose wadding on each side of the missile as shown.
- ⑫ Set a weapon system on each weapon system placed in step 8.
- ⑬ Run the pre-positioned tiedown strap placed in step 5 over the weapon systems and the missiles, and hook the strap with two D-rings and a load binder.

Figure 5-10. Trailer prepared (continued)

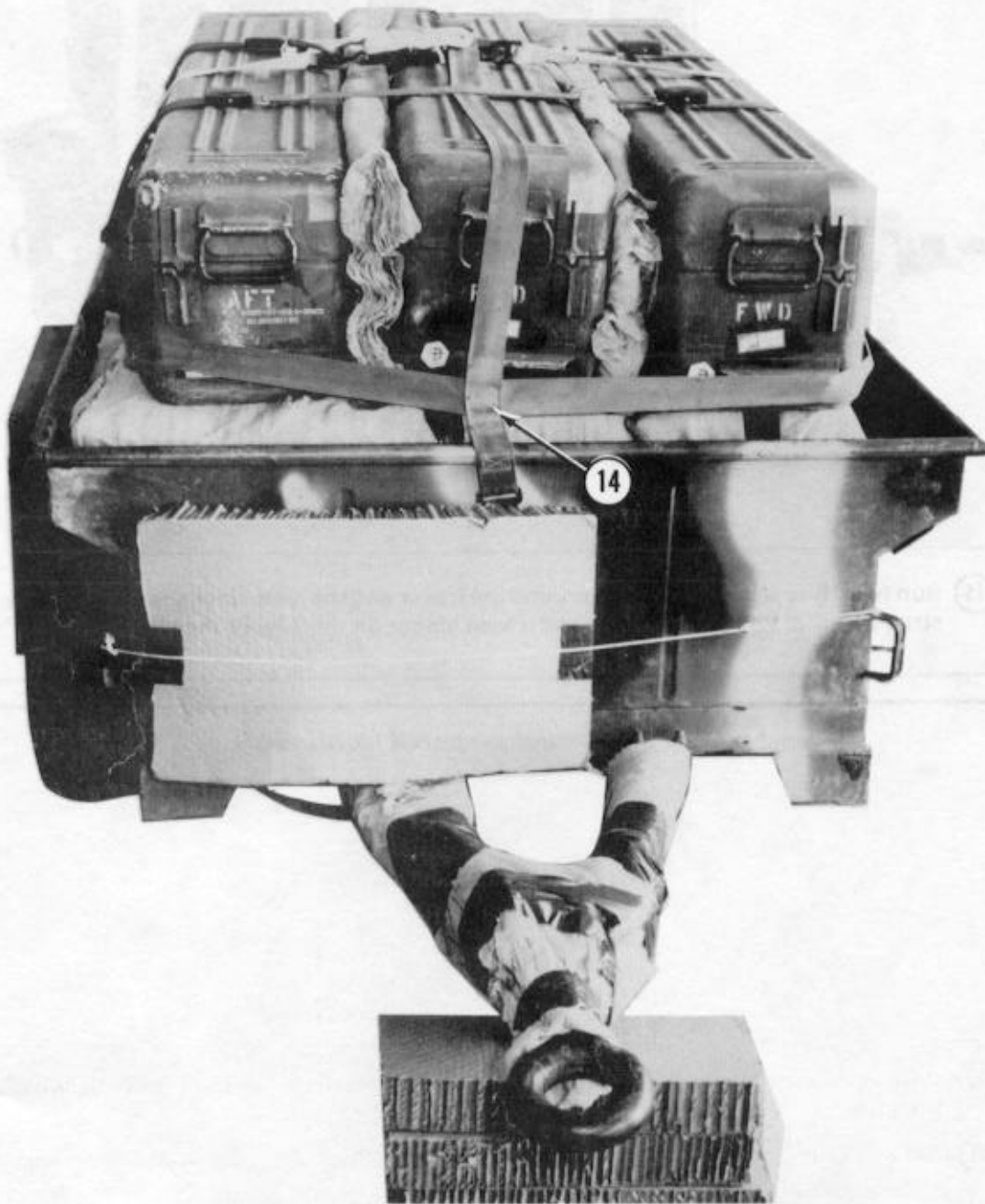

- ⑭ Place the tiedown web to cover the trailer load even if the trailer cover is available.

Figure 5-10. Trailer prepared (continued)

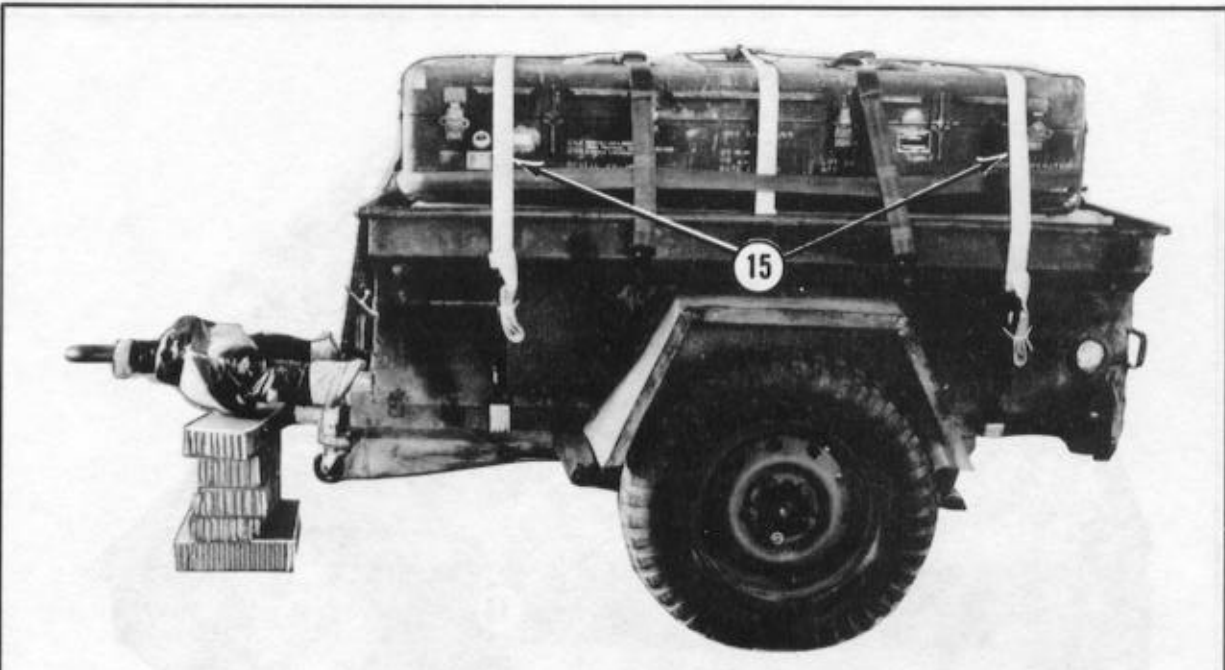

- ⑮ Run two 15-foot tiedown straps around the trailer and the load. Hook the ends of each strap together with two D-rings and a load binder on the side of the trailer.

Figure 5-10. Trailer prepared (continued)

5-7. Setting Truck and Trailer on Platform

Set the truck and trailer on the platform as shown in Figure 5-11. Set the truck on the platform with its rear end overhanging the front edge of the platform by 14 inches. Set

the trailer on the platform with the rear of the trailer flush against the front of the truck. Raise the support leg, and tie it in place with type III nylon cord.



Figure 5-11. Truck and trailer set on platform

5-8. Lashing Truck and Trailer to Platform

Lash the truck and trailer to the platform with sixteen 15-foot tiedown assemblies according to FM 10-500/TO 13C7-1-5 and as shown in Figures 5-12 and 5-13.

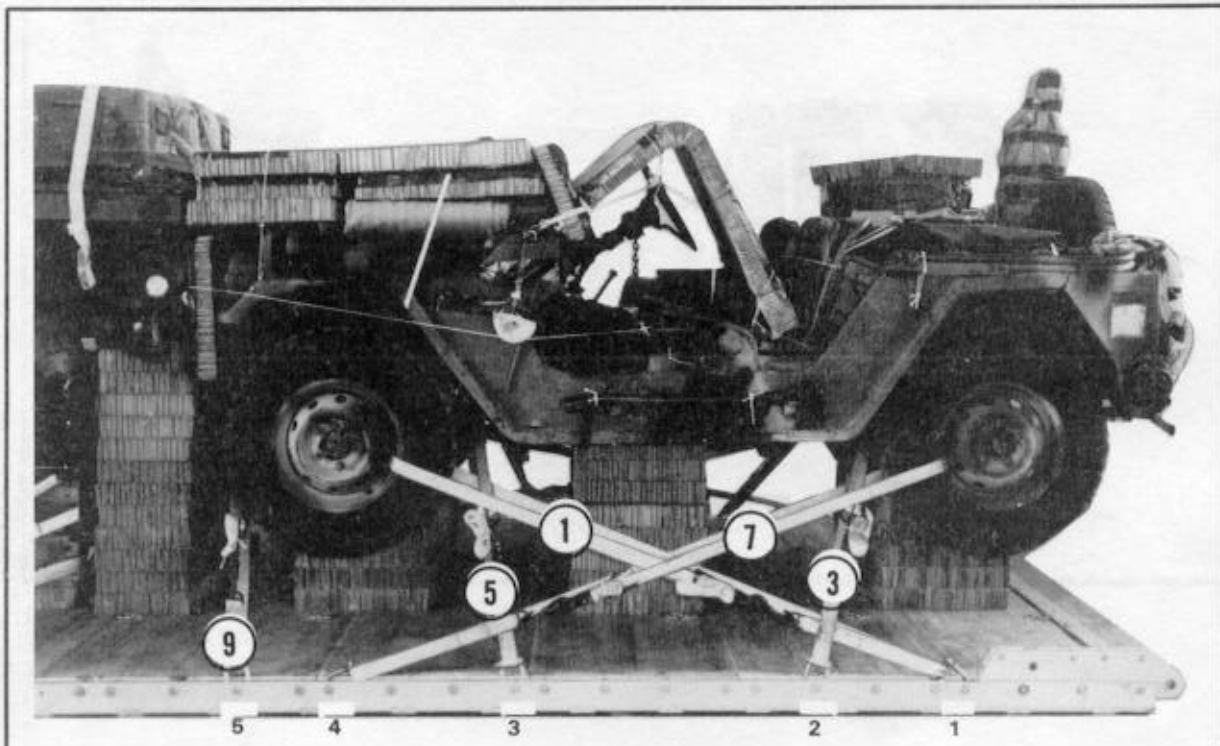

Lashing Number	Tiedown Clevis Number	Instructions
1	1	Pass lashing: Through left front wheel.
2	1A	Through right front wheel.
3	2	Around inner left rear suspension arm.
4	2A	Around inner right rear suspension arm.
5	3	Around left side of mainframe.
6	3A	Around right side of mainframe.
7	4	Through left rear wheel.
8	4A	Through right rear wheel.
9	5	Through left rear lifting handle.
10	5A	Through right rear lifting handle.

Figure 5-12. Truck lashed to platform

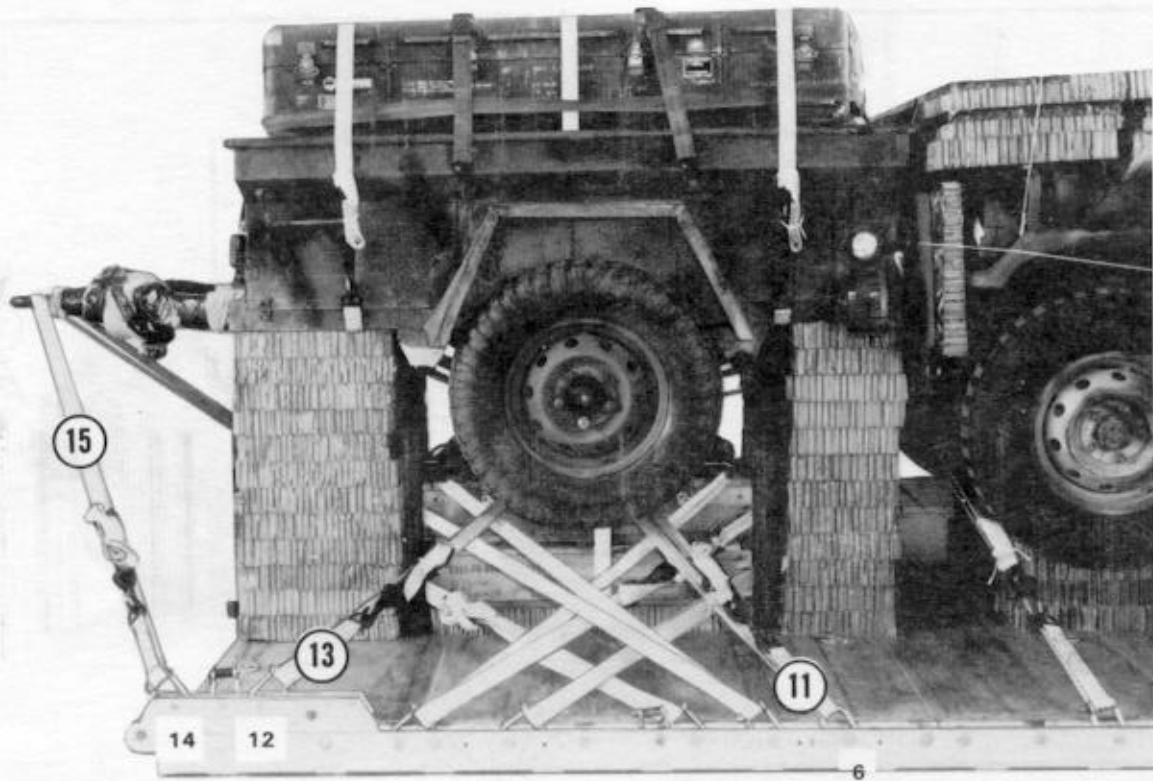

Lashing Number	Tiedown Clevis Number	Instructions
11	6	Pass lashing: Through left front spring bracket.
12	6A	Through right front spring bracket.
13	12	Through left rear spring bracket.
14	12A	Through right rear spring bracket.
15	14	Through lunette.
16	14A	Through lunette.

Figure 5-13. Trailer lashed to platform

5-9. Installing Load Cover

Install a 10- by 16-foot piece of cotton duck cloth over the load as shown in Figure 5-14.

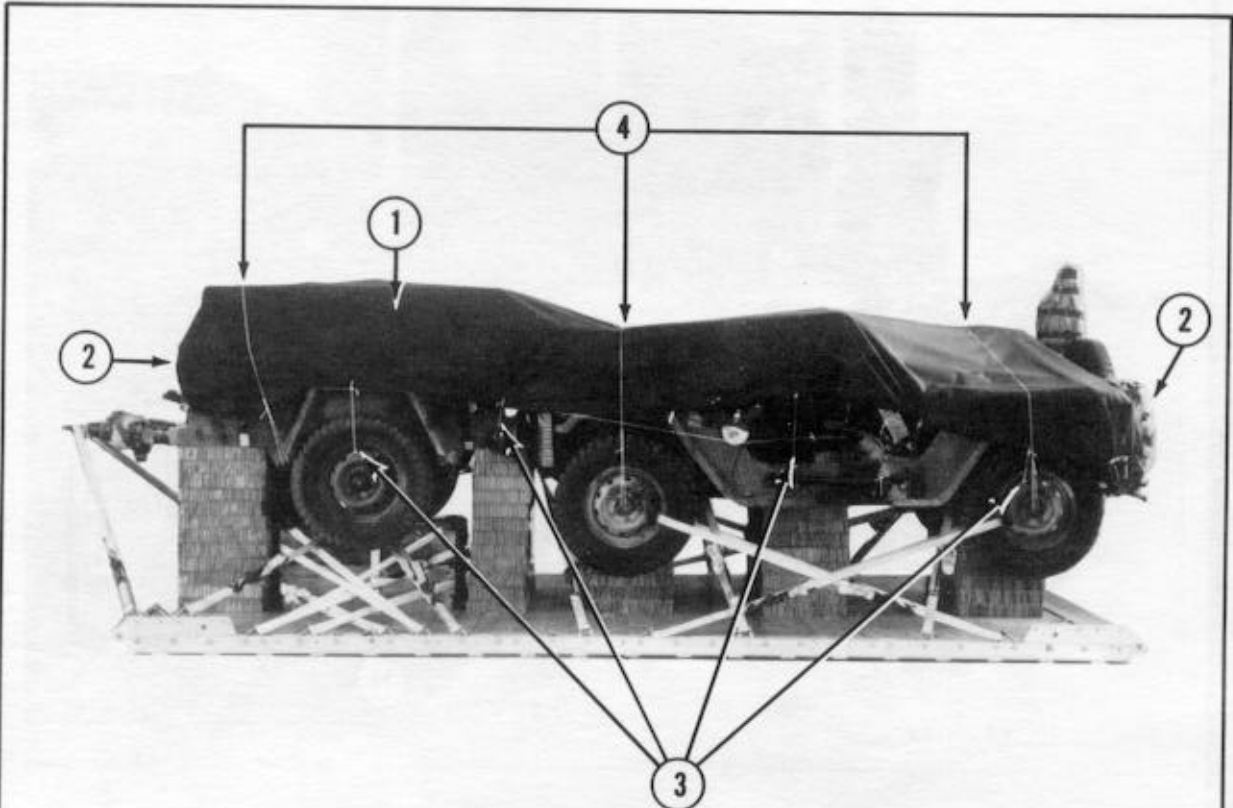

- ① Place a 10- by 16-foot piece of cotton duck cloth over the load.
- ② Secure the cover with type III nylon cord in three places on the front and three places on the rear of the load.
- ③ Secure the cover in four places to convenient points on each side of the load with type III nylon cord.
- ④ Secure the cover in three places with type III nylon cord run from the right side of the load, over the top, and to the left side of the load.

NOTE: The cover must be tight and neat for protection of the suspension slings and the load.

Figure 5-14. Load cover installed

5-10. Installing Suspension Slings and Antitumble Slings

Install and safety the suspension and antitumble slings as shown in Figure 5-15.

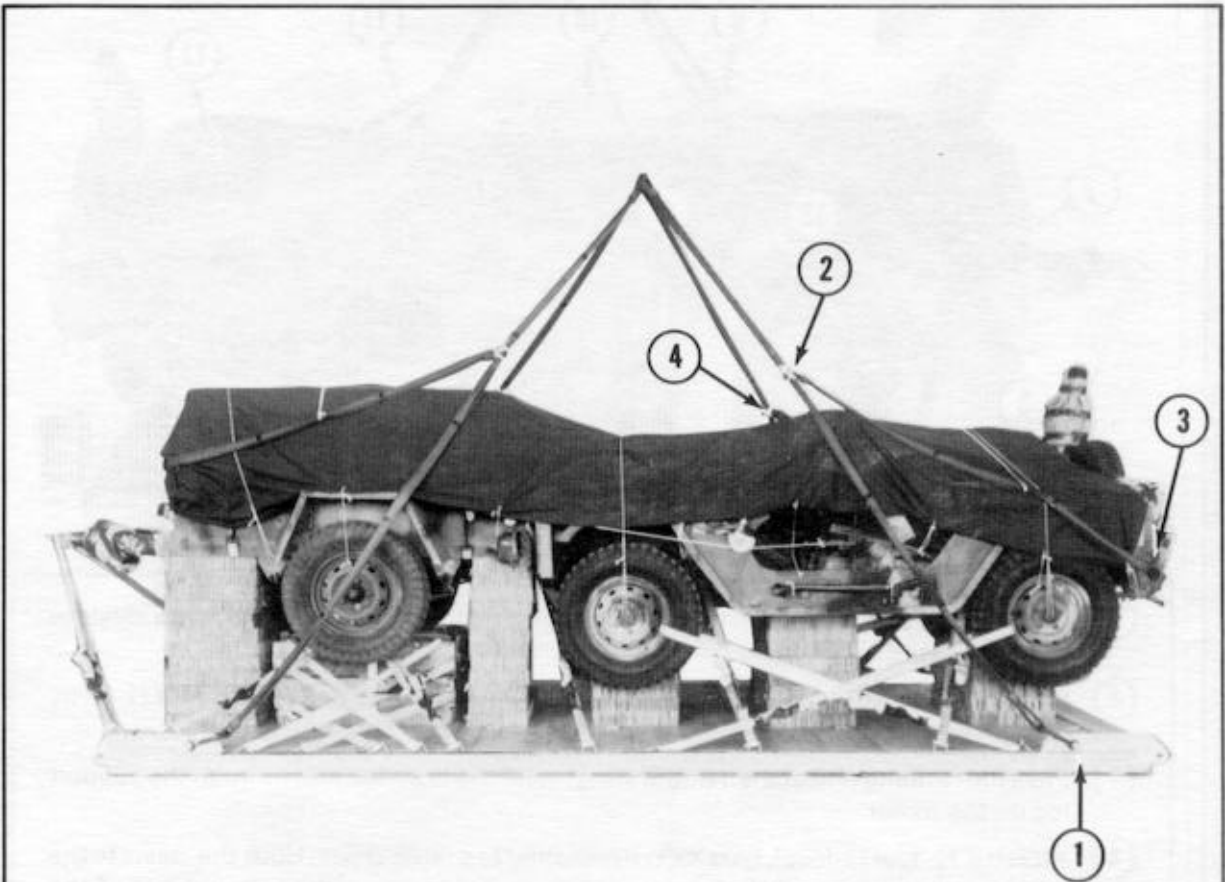

- ① Attach one 12-foot (2-loop), type XXVI nylon sling to a large clevis. Hook the clevis to the right front multipurpose link.
- ② Run the 12-foot (2-loop), type XXVI nylon sling through one end of a 20-foot (2-loop), type XXVI nylon sling.
- ③ Pass the running end of the 20-foot sling through the left rear lifting point, the pintle, and the right rear lifting point on the truck.
- ④ Attach a 12-foot (2-loop), type XXVI nylon sling to a large clevis. Hook the clevis to the left front multipurpose link. Pass the 12-foot sling through the running end of the 20-foot sling.

Figure 5-15. Slings installed and safetied

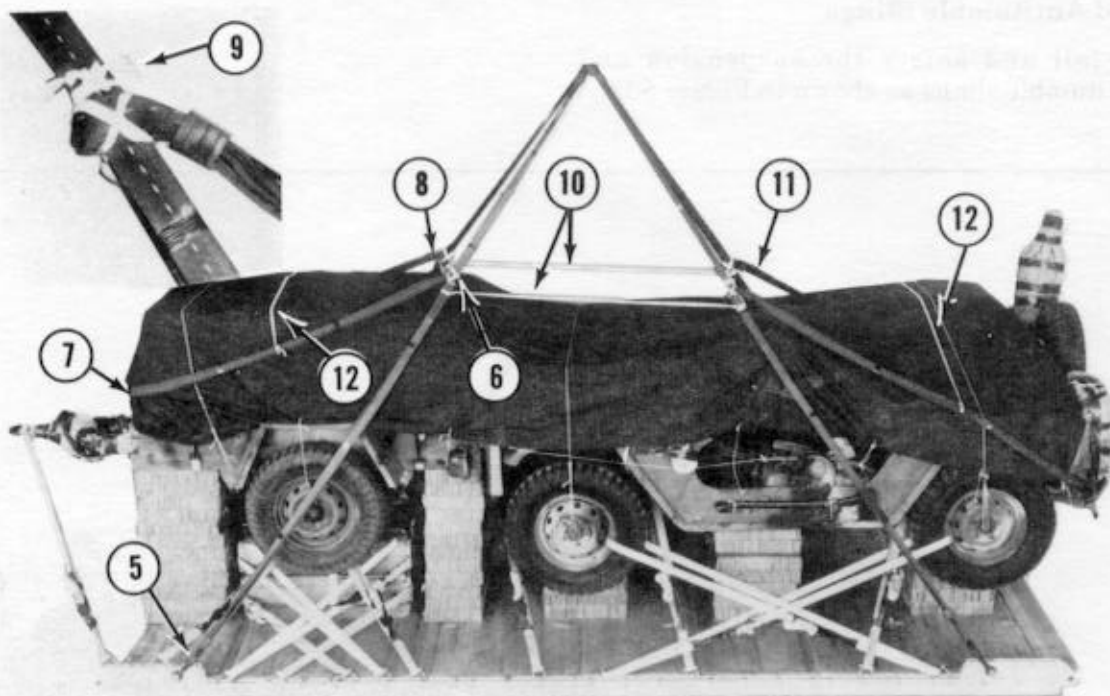

- ⑤ Attach one 12-foot (2-loop), type XXVI nylon sling to a large clevis. Hook the clevis to the right rear multipurpose link.
- ⑥ Run the 12-foot (2-loop), type XXVI nylon sling through one end of a 16-foot (2-loop), type XXVI nylon sling.
- ⑦ Pass the running end of the 16-foot sling under the drawbar and through the support leg on the trailer.
- ⑧ Attach a 12-foot (2-loop), type XXVI nylon sling to a large clevis. Hook the clevis to the left rear multipurpose link. Pass the 12-foot sling through the running end of the 16-foot sling.
- ⑨ Tie the antitumble slings to the suspension slings (see insert) with lengths of 1/2-inch tubular nylon webbing. Run the webbing through the plies of the suspension sling, and even the ends of the webbing. Run the ends around the rear of the suspension sling and back around to the front, crossing them. Run the ends around the antitumble sling, and tie them together above the sling with a surgeon's knot and a locking knot.
- ⑩ Place the deadman's tie below the antitumble slings.
- ⑪ Tape the ties and slings in place.
- ⑫ Secure the antitumble slings to the load with lengths of 1/2-inch tubular nylon webbing.

Figure 5-15. Slings installed and safetied (continued)

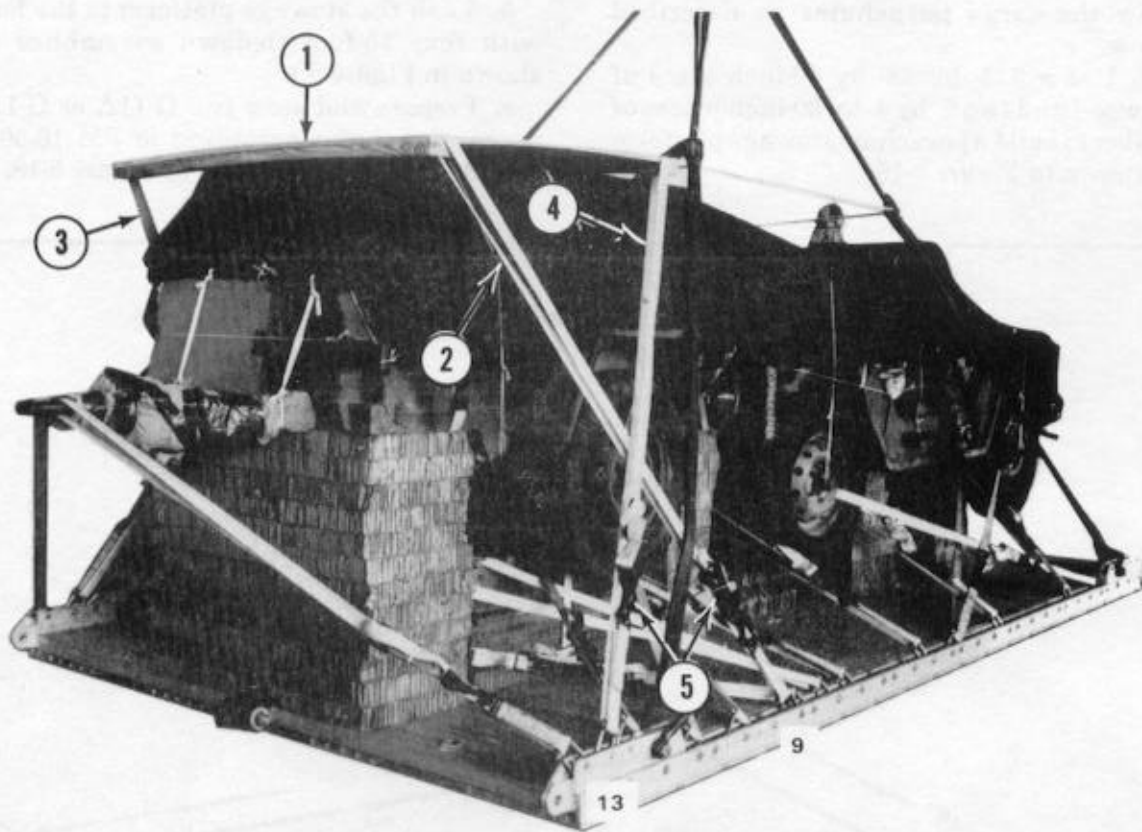

- ① Center the stowage platform crosswise on the front of the trailer.
- ② Run a 15-foot tiedown strap through the hole in the right rear hole of the stowage platform and through clevis 9. Fit a D-ring to the free ends of the strap, and hook the D-rings together with a load binder.
- ③ Run a second strap through the left rear hole and clevis 9A. Secure the strap as in step 2.
- ④ Run two more straps, one through the right front hole and through clevis 13 and one through the left front hole and through clevis 13A. Secure the straps as in step 2.
- ⑤ Pull the straps taut, and close the load binders. Fold the excess strap, and tie the folds to the binders with 80-pound cotton webbing.

Figure 5-17. Stowage platform secured

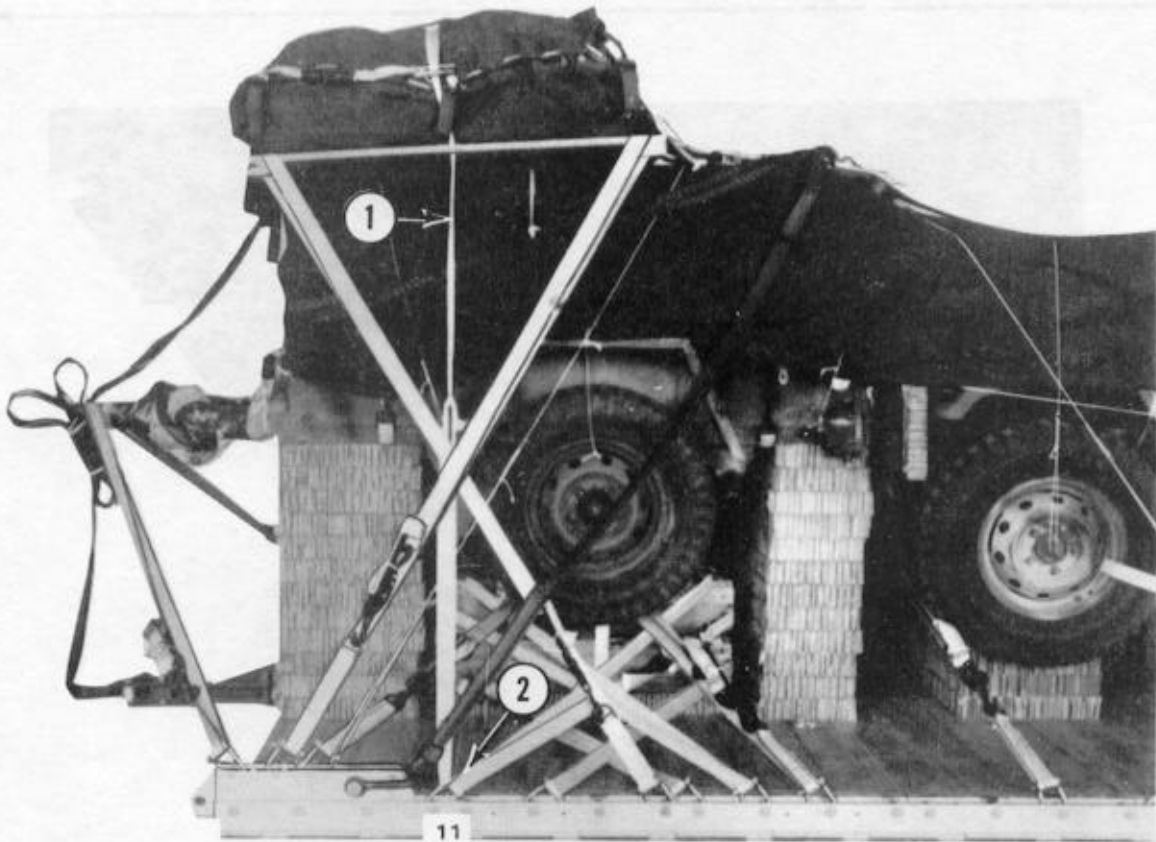

- ① Use a 10-yard length of type VIII nylon webbing to restrain the parachutes.
- ② Tie the restraint strap to clevises 11 and 11A.

Figure 5-18. Cargo parachutes stowed

5-12. Installing Extraction System

Attach the EFTC to the load according to FM 10-500/TO 13C7-1-5 and as shown in Figure 5-19.

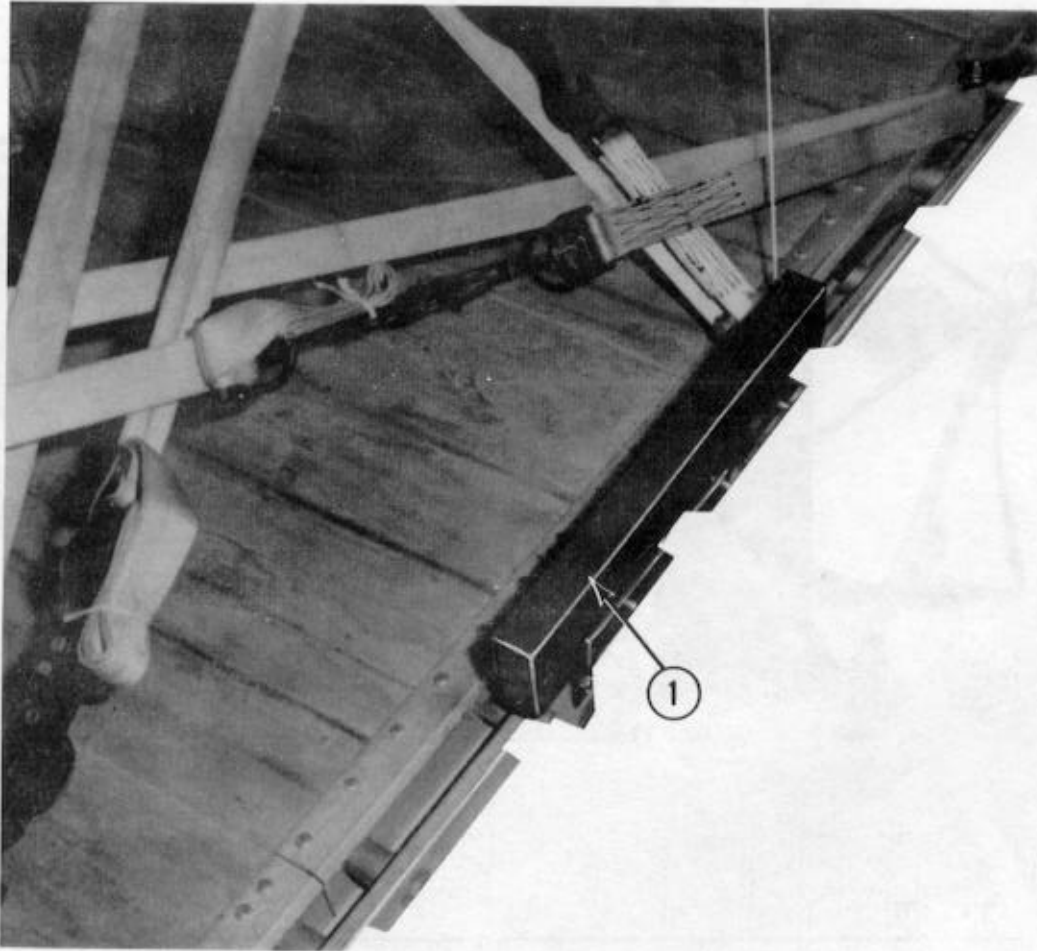

- ① Attach the EFTA brackets to the rearmost mounting holes on the left rail.
- ② Install the EFTC according to FM 10-500/TO 13C7-1-5 (not shown).
- ③ Use a 16-foot (3-loop), type X or 16-foot (2-loop), type XXVI nylon sling as a deployment line (not shown).

Figure 5-19. EFTC installed

5-13. Installing Release System

Prepare, attach, and safety an M-1 cargo parachute release according to FM 10-500/TO 13C7-1-5 and as shown in Figure 5-20.

CAUTION: Only the M-1 release is authorized for use with the G-11B cargo parachute.

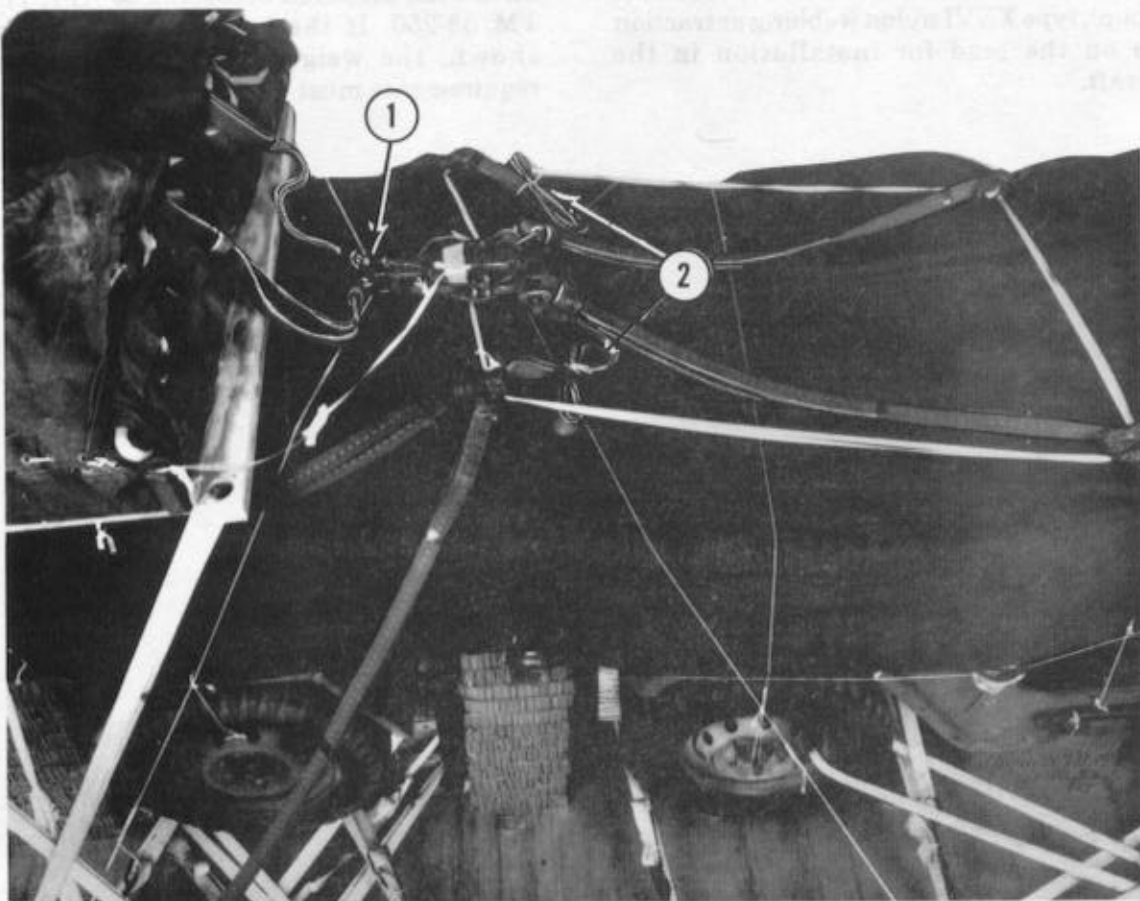

- ① Attach the release, fold any excess riser extensions, and tape the folds in place.
- ② Fold the excess suspension slings, and tie or tape the folds in place.

Figure 5-20. M-1 cargo parachute release installed

5-14. Placing Extraction Parachute

Place the extraction parachute on the load as given below.

a. C-130 Aircraft. Place an unreefed 15-foot cargo extraction parachute with a 60-foot (1-loop), type X or type XXVI nylon webbing extraction line on the load for installation in the aircraft.

b. C-141 Aircraft. Place an unreefed 15-foot cargo extraction parachute, a 36-inch adapter web, and a continuous 160-foot (1-loop), type XXVI nylon webbing extraction line on the load for installation in the aircraft.

5-15. Installing Emergency Restraint

Attach a medium clevis (emergency restraint) to each forward multipurpose link.

5-16. Marking Rigged Load

Mark the rigged load as outlined in FM 10-500/TO 13C7-1-5 and as shown in Figure 5-21. Complete DD Form 1387-2 (Special Handling Data/Certification), and securely attach it to the load. Indicate on the form that the vehicle fuel tank and battery have been prepared according to AFR 71-4/TM 38-250. If the load varies from that shown, the weight, CB, and parachute requirements must be recomputed.

CAUTION: Make the final rigger inspection required by AFR 55-40/AR 59-4 before the load leaves the rigging site.

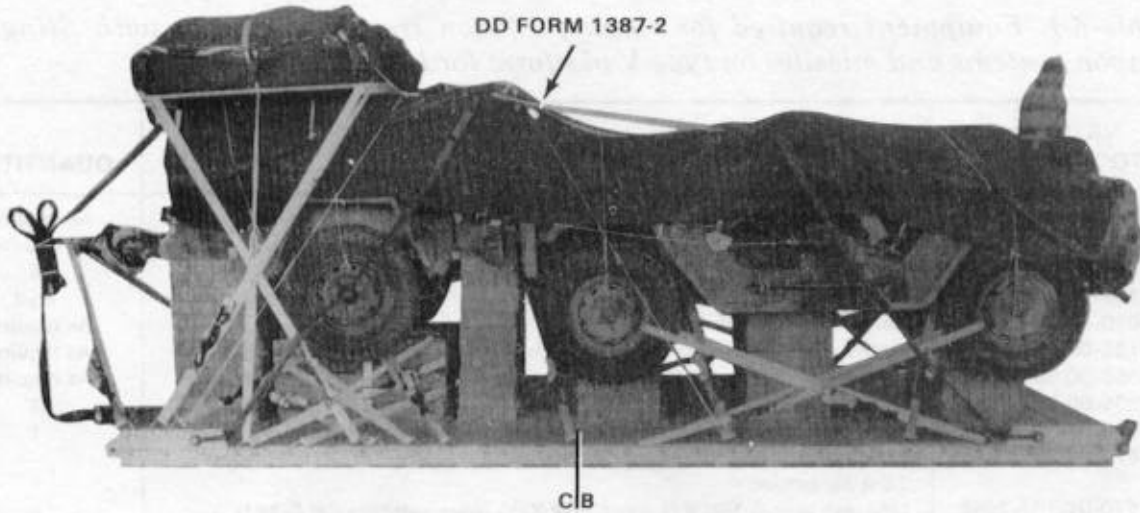

RIGGED LOAD DATA

Weight	7,400 pounds
Height	97 inches
Width	108 inches
Length	240 inches
Overhang: Front	14 inches
Rear	34 inches
Extraction System	EFTC
CB (from front edge of platform)	102 inches

Figure 5-21. Load rigged for low-velocity airdrop on a type V platform

5-17. Equipment Required

Use the equipment listed in Table 5-1 to rig this load. This table also includes equipment required for stowing the accompanying load of ammunition.

Table 5-1. Equipment required for rigging 1/4-ton truck and trailer with Stinger weapon systems and missiles on type V platform for low-velocity airdrop

NATIONAL STOCK NUMBER	ITEM	QUANTITY
8040-00-273-8713	Adhesive, paste, 1-gal	As required
1670-00-937-0272	Binder, load, 10,000-lb	As required
4030-00-090-5354	Clevis, suspension, 1-in (large)	4
8305-00-242-3593	Cloth, cotton duck, 60-in	8 yd
4020-00-240-2146	Cord, nylon, type III, 550-lb	As required
8135-00-664-6958	Cushioning material, packaging, cellulose wadding	As required
5365-00-937-0147	D-ring, heavy-duty, 10,000-lb	As required
8305-00-958-3685	Felt, 1/2-inch thick	1
1670-01-064-4452	Line, extraction, 60-ft (1-loop), type XXVI nylon webbing (for C-130) or	1
1670-00-856-0265	Line, extraction, 60-ft (1-loop), type X nylon webbing (for C-130) (use w 15-ft parachute)	1
1670-01-107-7652	Line, extraction, 160-ft (1-loop), type XXVI nylon webbing (for C-141)	1
1670-00-783-5988	Link assembly, type IV (for extraction line)	1
1670-00-217-2421	Link, L-bar type	2
1670-00-753-3928	Pad, energy-dissipating, honeycomb, 3- by 36- by 96-in:	15 sheets
	6- by 12-in	(4)
	6- by 18-in	(6)
	6- by 44-in	(1)
	12- by 16-in	(1)
	12- by 18-in	(8)
	12- by 42-in	(12)
	12- by 61-in	(1)
	14- by 24-in	(1)
	18- by 36-in	(14)
	18- by 42-in	(12)
	18- by 61-in	(4)
	24- by 61-in	(3)
	32- by 36-in	(1)
	36- by 36-in	(1)
	36- by 40-in	(2)
	36- by 47-in	(2)
	Parachute, cargo:	
1670-00-269-1107	G-11A or	2
1670-01-016-7841	G-11B	2
1670-01-063-3715	Parachute, cargo extraction, 15-ft (unreefed)	1
	Platform, airdrop, type V, 16-ft:	
1670-01-162-2375	Bracket, inside EFTA	1
1670-01-162-2374	Bracket, outside EFTA	1
1670-01-162-2372	Clevis, load tiedown	28
1670-00-434-5785	Coupling, airdrop extraction force transfer w 16-foot cable	1
1670-01-162-2376	Extraction bracket assembly	1
1670-01-162-2381	Multipurpose link	4
1670-01-162-2382	Pad, roller, 16-ft	4
1670-01-168-8397	Panel, platform, main	7
1670-01-168-8398	Panel, platform, rear	1

Table 5-1. Equipment required for rigging 1/4-ton truck and trailer with Stinger weapon systems and missiles on type V platform for low-velocity airdrop (continued)

NATIONAL STOCK NUMBER	ITEM	QUANTITY
1670-01-162-2369	Rail, platform, side, 16-ft:	2
5306-01-212-1264	Bolt, 1/2- by 3 13/64-in	(64)
1670-01-162-2384	Bushing	(64)
5310-00-167-0823	Washer, flat, 7/16-in	(64)
	Platform, parachute stowage:	
5510-00-220-6146	Lumber, 2- by 4- by 60-in	2
5315-00-010-4659	Nail, steel wire, common, 8d	As required
5530-00-128-4981	Plywood, 3/4- by 48- by 60-in	1
5530-00-128-4981	Plywood, 3/4-in:	3 sheets
	18- by 36-in	(2)
	18- by 44-in	(1)
	36- by 70-in	(1)
1670-01-097-8816	Release, cargo parachute, M-1	1
	Sling, cargo, airdrop:	
1670-00-753-3788	3-ft (3-loop), type X nylon webbing or	4
1670-01-062-6301	3-ft (2-loop), type XXVI nylon webbing	4
1670-00-823-5041	12-ft (3-loop), type X nylon webbing or	4
1670-01-062-6303	12-ft (2-loop), type XXVI nylon webbing	4
1670-00-823-5042	16-ft (3-loop), type X nylon webbing or	2
1670-01-063-7761	16-ft (2-loop), type XXVI nylon webbing	2
1670-00-823-5043	20-ft (3-loop), type X nylon webbing or	1
1670-01-062-6302	20-ft (2-loop), type XXVI nylon webbing	1
1670-00-753-3794	20-ft (2-loop), type X nylon webbing (for riser extensions) or	2
1670-01-062-6302	20-ft (2-loop), type XXVI nylon webbing	2
7510-00-266-5016	Tape, adhesive, 2-in	As required
1670-00-937-0271	Tiedown assembly, 15-ft	51
1670-00-040-8215	Web, adapter, 36-in (for 15-ft parachute)	1
	Webbing:	
8305-00-268-2411	Cotton, 80-lb	As required
8305-00-082-5752	Nylon, tubular, 1/2-in, 1,000-lb, natural	As required
8305-00-263-3591	Nylon, type VIII, 3,600-lb	As required

CHAPTER 6

RIGGING 1 1/4-TON TRUCK WITH STINGER WEAPON SYSTEMS AND MISSILES FOR LOW-VELOCITY AIRDROP

6-1. Description of Load

The M998, 1 1/4-ton truck (HMMWV), equipped with the stinger weapon system rack and loaded with six stinger weapon systems and items of truck equipment, is rigged on a 16-foot, type V platform. The load requires two G-11 parachutes. The accompanying load rigged in the truck weighs 1,180 pounds.

6-2. Preparing Platform, Preparing and Positioning Honeycomb Stacks, and Preparing Truck

Prepare the platform, prepare and position the honeycomb stacks, and prepare the truck according to FM 10-517/TO 13C7-1-111.

6-3. Rigging Weapon Systems and Truck Equipment in Truck

Secure the truck equipment to the truck as shown in Figure 6-1. Secure the weapon systems in their rack as shown in Figure 6-2. Secure the truck tailgate and install body side protection boards according to FM 10-517/TO 13C7-1-111.

6-4. Lifting, Positioning, and Lashing the Truck

Lift, position, and lash the truck to the platform according to FM 10-517/TO 13C7-1-111.

NOTES: 1. All measurements are given in inches.

2. This drawing is not to scale.

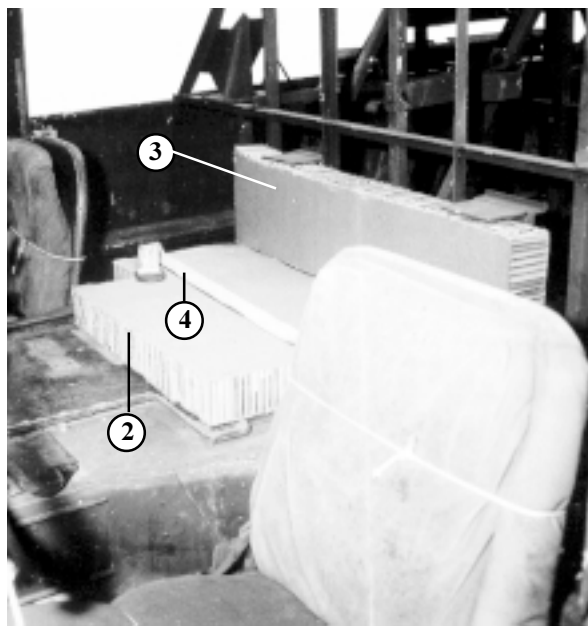
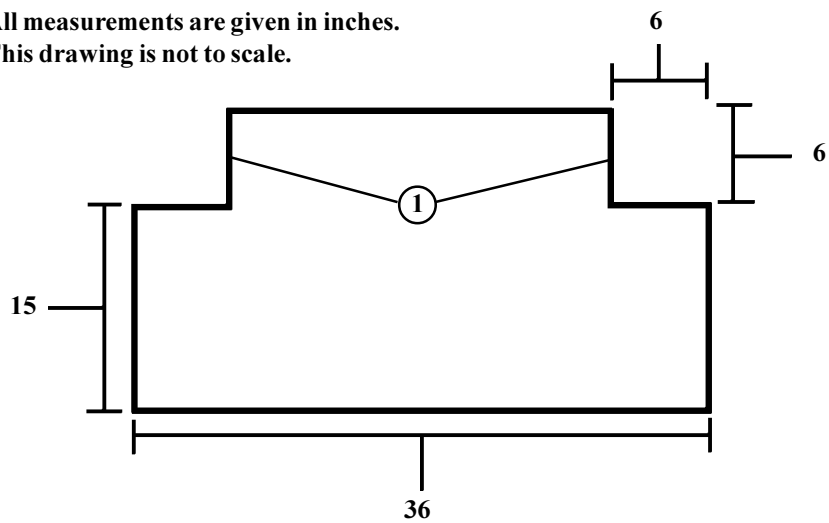

- ① Make 6- by 6-inch cutouts in a 21- by 36-inch piece of honeycomb as shown.
- ② Center the honeycomb behind the seats with the cutouts facing the front and the rear edge against the missile rack.
- ③ Place an 8- by 36-inch piece of honeycomb on top of the honeycomb placed in step 2 above and the two edges on the missile rack.
- ④ Place a 15-foot lashing on the honeycomb.

Figure 6-1. Truck equipment secured to truck



5 Place a 12- by 36-inch piece of honeycomb on edge over the honeycomb placed in step 3.



6 Place a 20- by 36-inch piece of honeycomb on edge against the honeycomb placed in steps 3 and 5.

Figure 6-1. Truck equipment secured to truck (continued)

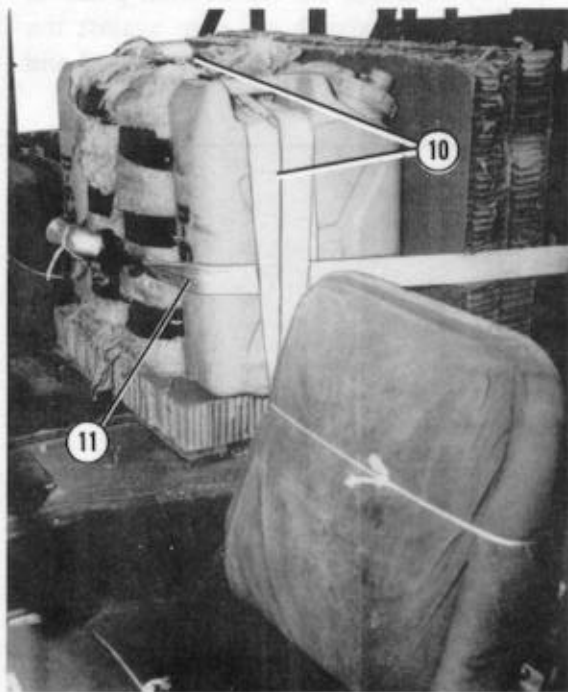
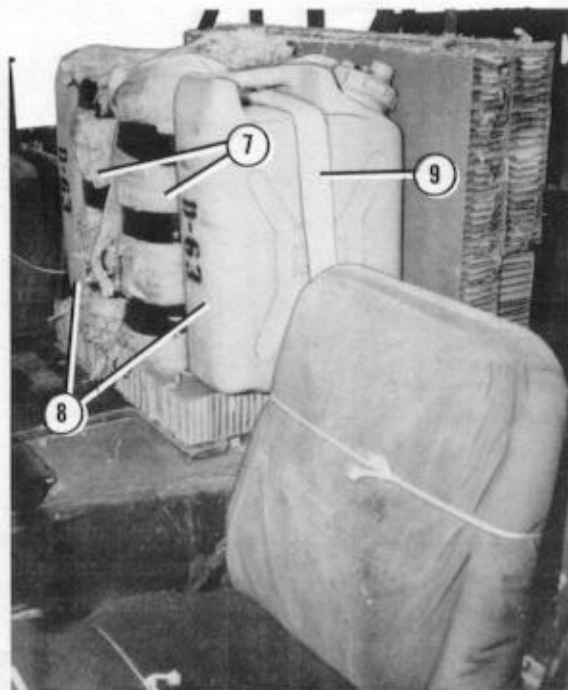

- ⑦ Pad two fuel cans with cellulose wadding taped in place. Center the cans on the honeycomb over the cargo bed.
- ⑧ Set a water can on each side of the fuel cans.
- ⑨ Pass the lashing placed in step 4 through all the can handles. Fasten the lashing on the right side with a D-ring and a load binder.
- ⑩ Pass a 15-foot lashing through all the can handles and through the cargo bed tie-down rings on each side of the cans. Pass each end of the lashing through the water can handles. Fasten the lashing over the fuel can handles with a D-ring and a load binder.
- ⑪ Pass a 15-foot lashing around the front vertical bars of the missile rack and around the cans. Fasten the lashing in front of the cans with a D-ring and a load binder.

Figure 6-1. Truck equipment secured to truck (continued)

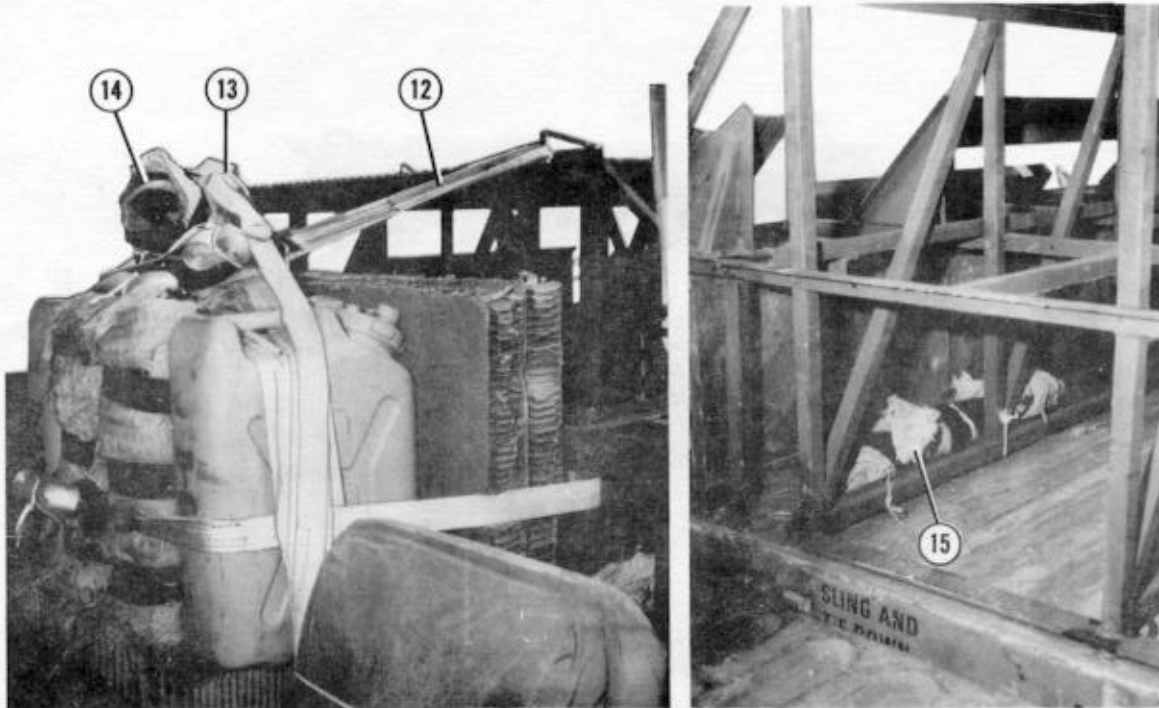

- ⑫ Pass a 15-foot lashing through the left tie-down provision on top of the rack and across the cans to the right cargo bed tie-down ring. Fasten the lashing over the cans with a D-ring and a load binder.
- ⑬ Pass a 15-foot lashing through the right tie-down provision on top of the rack and across the cans to the left cargo bed tie-down ring. Fasten the lashing over the cans with a D-ring and a load binder.
- ⑭ Remove the pioneer tools from their rack under the truck. Secure the rack with the straps provided (not shown). Pad the tools with cellulose wadding taped in place. Tie the tools to the right front vertical bar of the missile rack with 1/2-inch tubular nylon webbing.
- ⑮ Pad the radio antenna sections with cellulose wadding taped in place. Place them on the floor, and tie them to the left side of the rack with type III nylon cord.

Figure 6-1. Truck equipment secured to truck (continued)

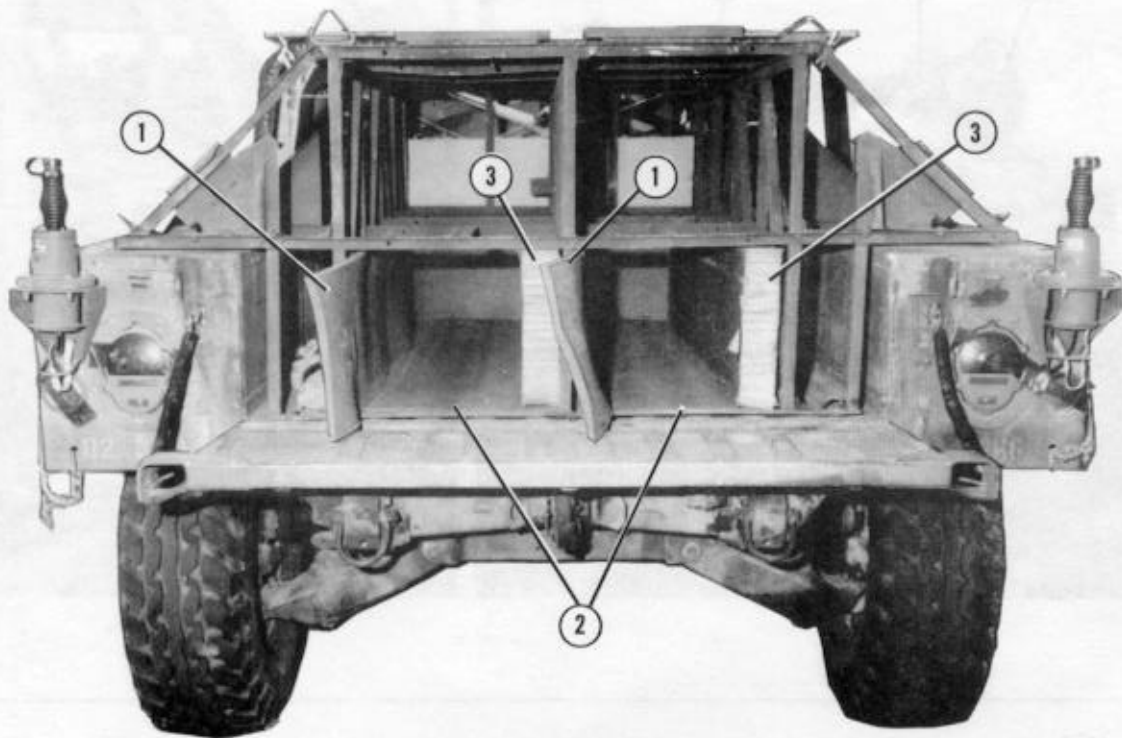

- ① Place a 13- by 100-inch piece of felt on edge against the left side of each lower rack compartment.
- ② Place one 16- by 66-inch piece of felt flat on the floor of each lower rack compartment.
- ③ Place one 13- by 66-inch piece of honeycomb on edge against the right side of each lower rack compartment.

Figure 6-2. Weapon systems secured to rack

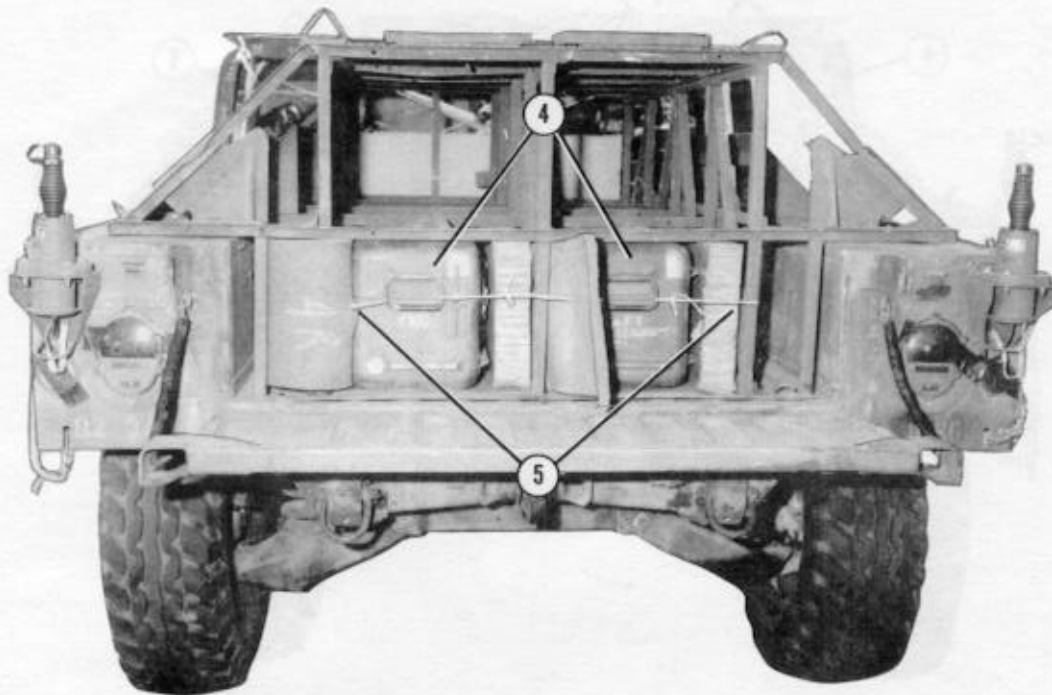

- ④ Place a weapon system case in each lower rack compartment. Be sure that enough of the felt placed in step 1 remains outside the rear of each rack compartment to cover the end of the weapon system case when folded over.
- ⑤ Secure each weapon system case to the vertical rack bars at the rear with type III nylon cord tied to the case handles. Cut a slit in the felt to allow for the ties.

Figure 6-2. Weapon systems secured to rack (continued)

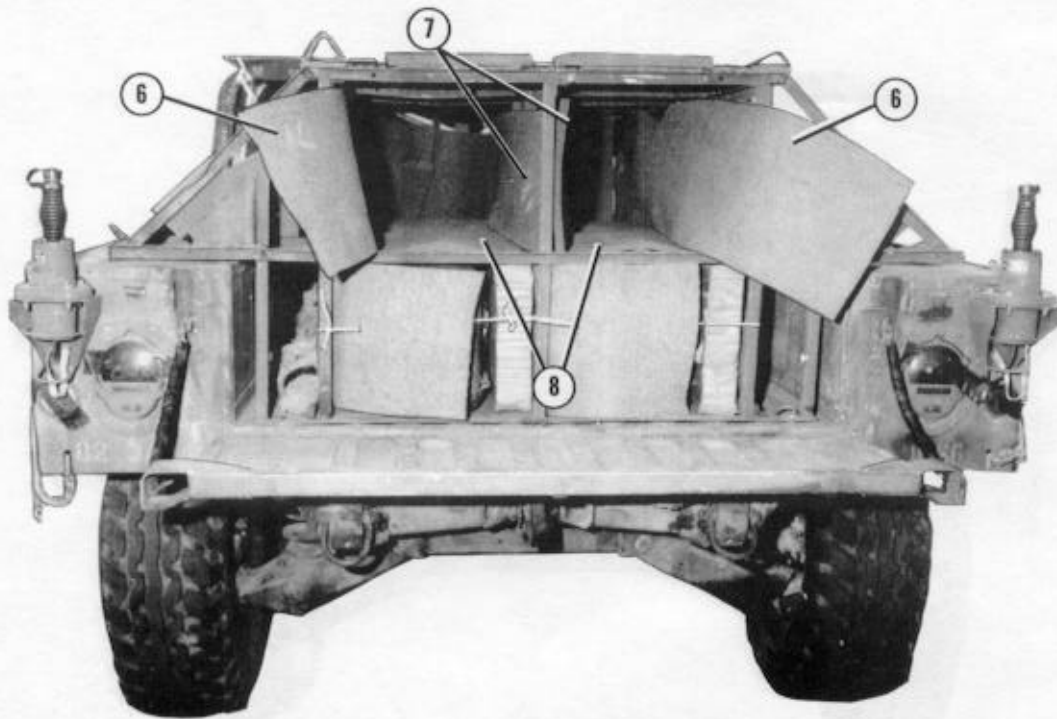

- ⑥ Place a 13- by 100-inch piece of felt on edge against the outside wall of each upper rack compartment.
- ⑦ Place a 13- by 66-inch piece of felt on edge against the inside wall of each upper rack compartment.
- ⑧ Place a 16- by 66-inch piece of felt flat on the floor of each upper rack compartment.

Figure 6-2. Weapon systems secured to rack (continued)

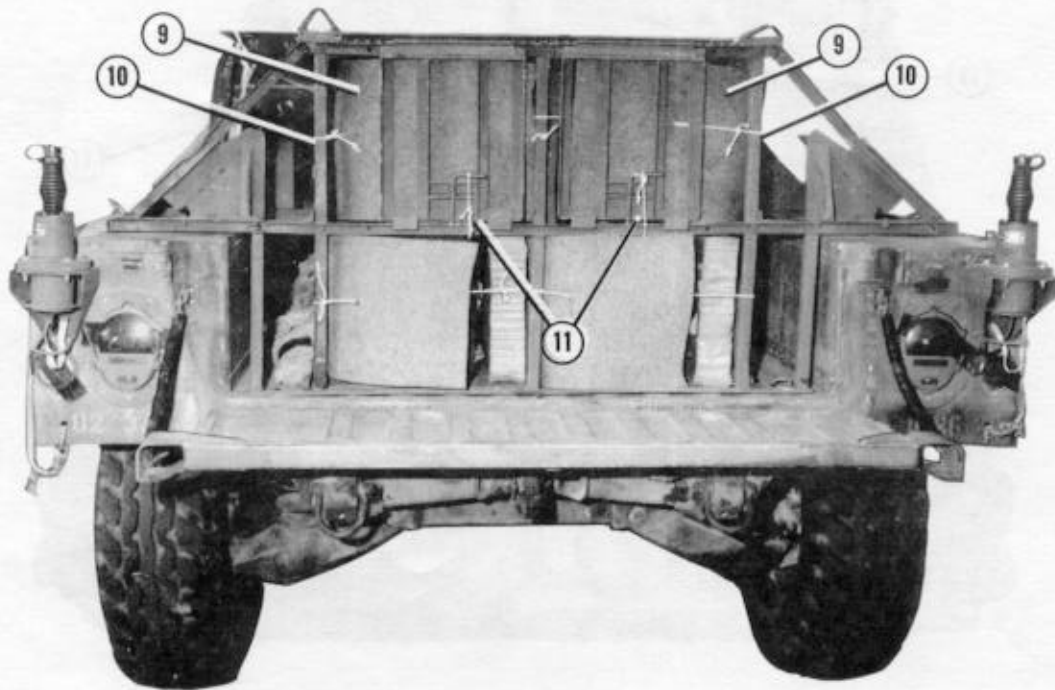

- ⑨ Place a weapon system case in each upper rack compartment. Be sure that enough of the felt placed in step 6 remains outside the rear of each rack compartment to cover the end of the weapon system case when folded over.
- ⑩ Secure each weapon system case to the vertical rack bars at the rear with type III nylon cord tied to the case handles. Cut a slit in the felt to allow for the ties.
- ⑪ Fold the felt over the weapon system cases in all four compartments. Close and latch the upper compartment doors, and secure the latches with type III nylon cord.

Figure 6-2. Weapon systems secured to rack (continued)

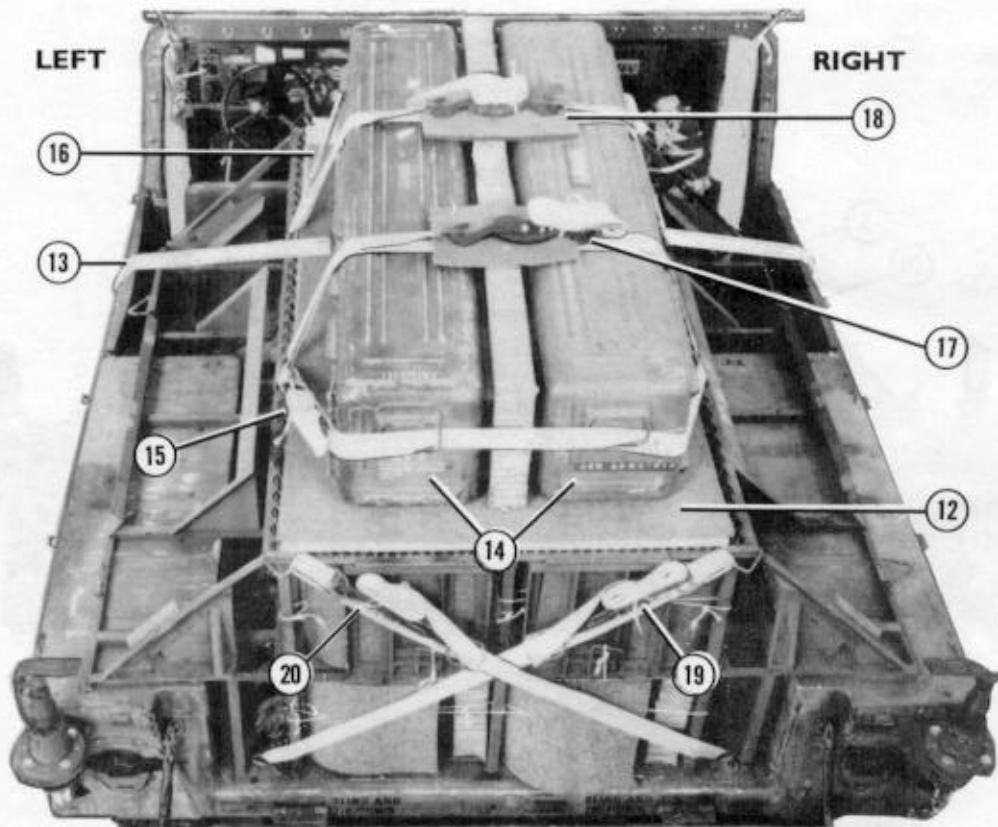

(12) Drill a 1/2-inch hole in each corner of a 36- by 70-inch piece of 3/4-inch plywood. Center the plywood on top of the missile rack, and tie the corners of the plywood to the rack with 1/2-inch tubular nylon webbing.

(13) Pass a 30-foot lashing over the plywood and under the vehicle. Fasten the lashing under the vehicle with two D-rings and a load binder.

NOTE: This lashing is to secure the cage to the vehicle upon impact.

(14) Place a 36- by 66-inch piece of felt over the lashing and plywood. Center two weapon system cases over the plywood and felt with a 13- by 66-inch piece of honeycomb placed between the cases.

(15) Pass a 15-foot lashing through the rear weapon system case handles and through the rear side tie-down provisions. Fasten the lashing on the left with a D-ring and a load binder.

Figure 6-2. Weapon systems secured to rack (continued)

- ⑩ Pass a 15-foot lashing through the front weapon system case handles and through the front side tie-down provisions. Fasten the lashing on the right with a D-ring and a load binder.
- ⑪ Pass a 15-foot lashing across the tops of the cases and through the rear side tie-down provisions. Fasten the lashings on top of the boxes with a D-ring and load binder. Pad under the load binder with 1/2-inch felt.
- ⑫ Pass a 15-foot lashing across the tops of the cases and through the front side tie-down provisions. Fasten the lashings on top of the boxes with a D-ring and load binder. Pad under the load binder with 1/2-inch felt.
- ⑬ Lash the left rear tie-down ring to the right upper tie-down provision on the rack with a 15-foot lashing. Secure with D-ring and load binder.
- ⑭ Lash the right rear tie-down ring to the left upper tie-down provision on the rack in the same way as in step 19 above.

NOTE: Position the load binders on the lashings in steps 18 and 19 above so that they will not contact the tailgate when it is closed.

Figure 6-2. Weapon system secured to rack (continued)

6-5. Installing and Safetying Suspension Slings

Install and safety the suspension slings according to FM 10-517/TO 13C7-1-111.

6-6. Installing Cargo Parachutes, Extraction System, Provisions for Emergency Restraints, Cargo Parachute Release, and Cargo Extraction Parachutes

Finish rigging the load according to FM 10-517/TO 13C7-1-111, Chapter 2 and FM 10-500-2/TO 13C7-1-5.

6-7. Marking Rigged Load

Mark the rigged load according to FM 10-500-2/TO 13C7-1-5 and as shown in Figure 6-3.

6-8. Equipment Required

Use the equipment listed in Table 6-1 to rig six stinger weapon systems in a 1 1/4-ton HMMWV truck. Equipment for rigging the truck is listed in FM 10-517/TO 13C7-1-111, Table 2-2.

CAUTION
Make the final rigger inspection required by FM 10-500-2/TO 13C7-1-5
before the load leaves the rigging site.

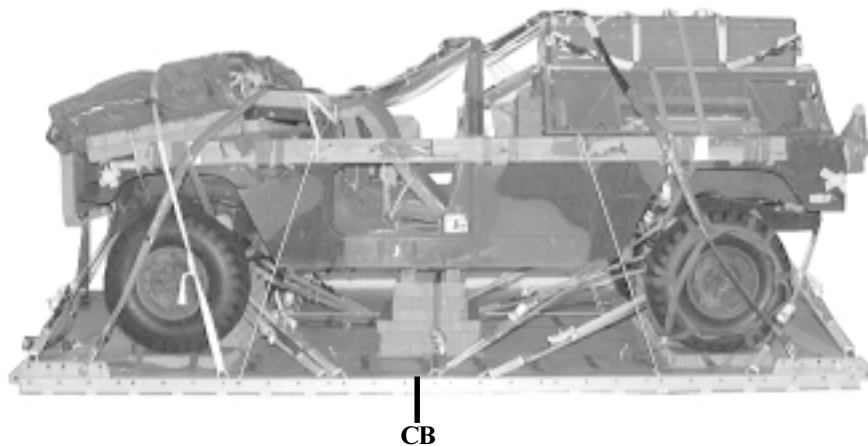

RIGGED LOAD DATA

Weight.....	8,830 pounds
Maximum Weight.....	10,500 pounds
Height.....	92 inches
Width.....	108 inches
Overall Length.....	210 inches
Overhang: Front.....	0 inches
Rear (EFTC).....	18 inches
Center of Balance (CB).....	95 inches
Extraction System.....	EFTC

Figure 6-3. M998, 1 1/4-ton truck with six stinger weapon systems rigged for low-velocity airdrop

Table 6-1. Equipment required for rigging six stinger weapon systems in the M998, 1 1/4-ton truck for low-velocity airdrop

NATIONAL STOCK NUMBER	ITEM	QUANTITY
4020-00-240-2146	Cord, nylon, type III, 550-lb	As required
8135-00-664-6958	Cushioning material, packaging, cellulose wadding	As required
8305-00-958-3685	Felt, 1/2-inch thick	As required
1670-00-753-3928	Pad, energy-dissipating, honeycomb, 3- by 36- by 96-in: 8- by 36-in 12- by 36-in 13- by 66-in 20- by 36-in 21- by 36-in	2 sheets (1) (1) (3) (1) (1)
5530-00-128-4981	Plywood, 3/4-in: 36- by 70-in	1
7510-00-266-5016	Tape, adhesive, 2-in	As required
1670-00-937-0271	Tie-down assembly, 15-ft	13
8305-00-268-2411	Webbing: Cotton, 1/4-inch, type I	As required
8305-00-082-5752	Nylon, tubular: 1/2-in	As required

CHAPTER 7

RIGGING 1 1/4-TON TRUCK WITH AN AVENGER WEAPON SYSTEM ON A 28-FOOT, TYPE V PLATFORM FOR LOW-VELOCITY AIRDROP

7-1. Description of Load

The Avenger is a turret-configured weapon system mounted on a modified M1097 1 1/4-HMMWV-series truck. There are two configurations of the system, the Avenger without the Environmental Control Unit (ECU) mounted on a modified M1097-series truck and the Avenger with an upgraded ECU mounted on a modified M1097-series truck. The Avenger is shown in Figure 7-1 in the travel position. The weapons consist of two missile pods, a 50-caliber machine gun, and guidance system. The turret is removed from the truck and rigged on a 28-foot type V platform with the truck.

This load requires three G-11 parachutes.

7-2. Preparing Platform

Prepare a 28-foot, type V airdrop platform as shown in Figure 7-2.

NOTES:

1. The nose bumper may or may not be installed.
2. Measurements given in this load are from the front edge of the platform, NOT from the front edge of the nose bumper.

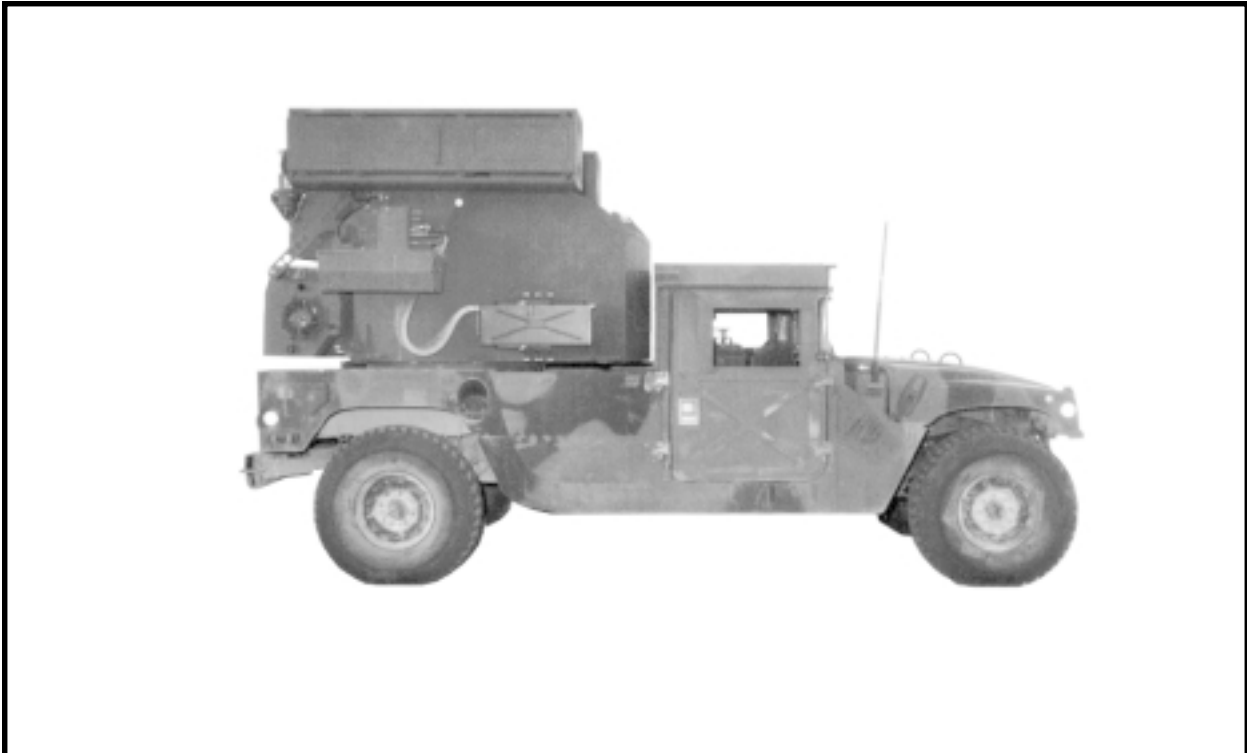
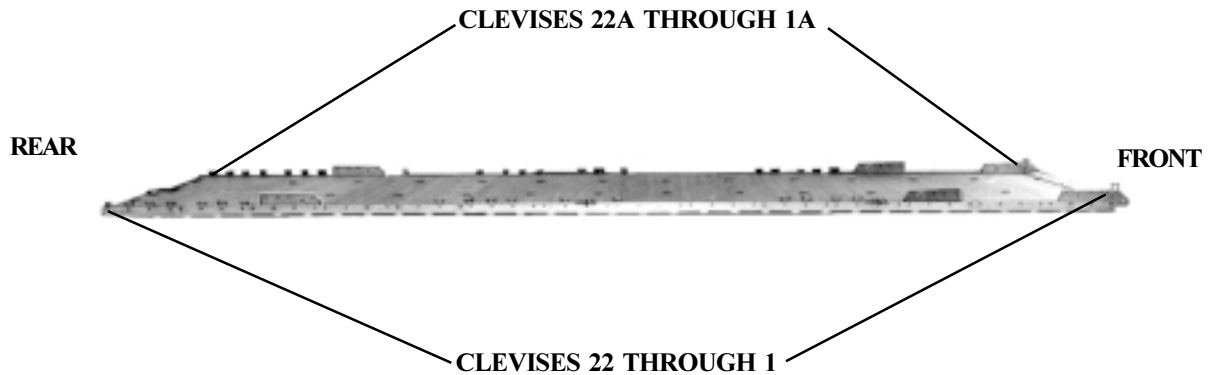

Figure 7-1. Avenger air defense weapon system with ECU on M1097 truck



Step:

1. Inspect, or assemble and inspect, a 28-foot, type V airdrop platform as outlined in TM 10-1670-268-20&P/TO 13C7-52-22.
2. Install a suspension link to the right and left platform side rails using holes 10, 11, and 12.
3. Install a tandem link to the front of each platform side rail using holes 1, 2, and 3.
4. Install a suspension link to the right and left platform side rails using holes 45, 46, and 47.
5. Install a clevis on bushing 1 of each tandem link.
6. Starting at the front of each platform side rail, install clevises on the bushings bolted to holes 14 (triple clevis), 15, 16, 18, 19, 28, 30 (triple clevis), 31, 34, 35, 36, 38, 49, 50, 51, 53, 54, 55, and 56.
7. Starting at the front of the platform, number the clevises 1 through 22 on the right side, and 1A through 22A on the left side.
8. Label the tie-down rings according to FM 10-500-2/TO 13C7-1-5.

Figure 7-2. Platform prepared

7-3. Preparing and Positioning Honeycomb Stacks and Strongback

Prepare honeycomb stacks 1, 2, and 3 for the truck as shown in Figures 2-3 and 2-4, FM 10-517/TO 13C7-1-111. Prepare honeycomb stacks 4 and 5 for the turret as shown

in Figure 7-3. Position the honeycomb stacks as shown in Figure 7-4. Construct the strongback as shown in Figure 7-5. Position the strongback on the honeycomb stacks and install the drive off aid on the platform as shown in Figure 7-6.

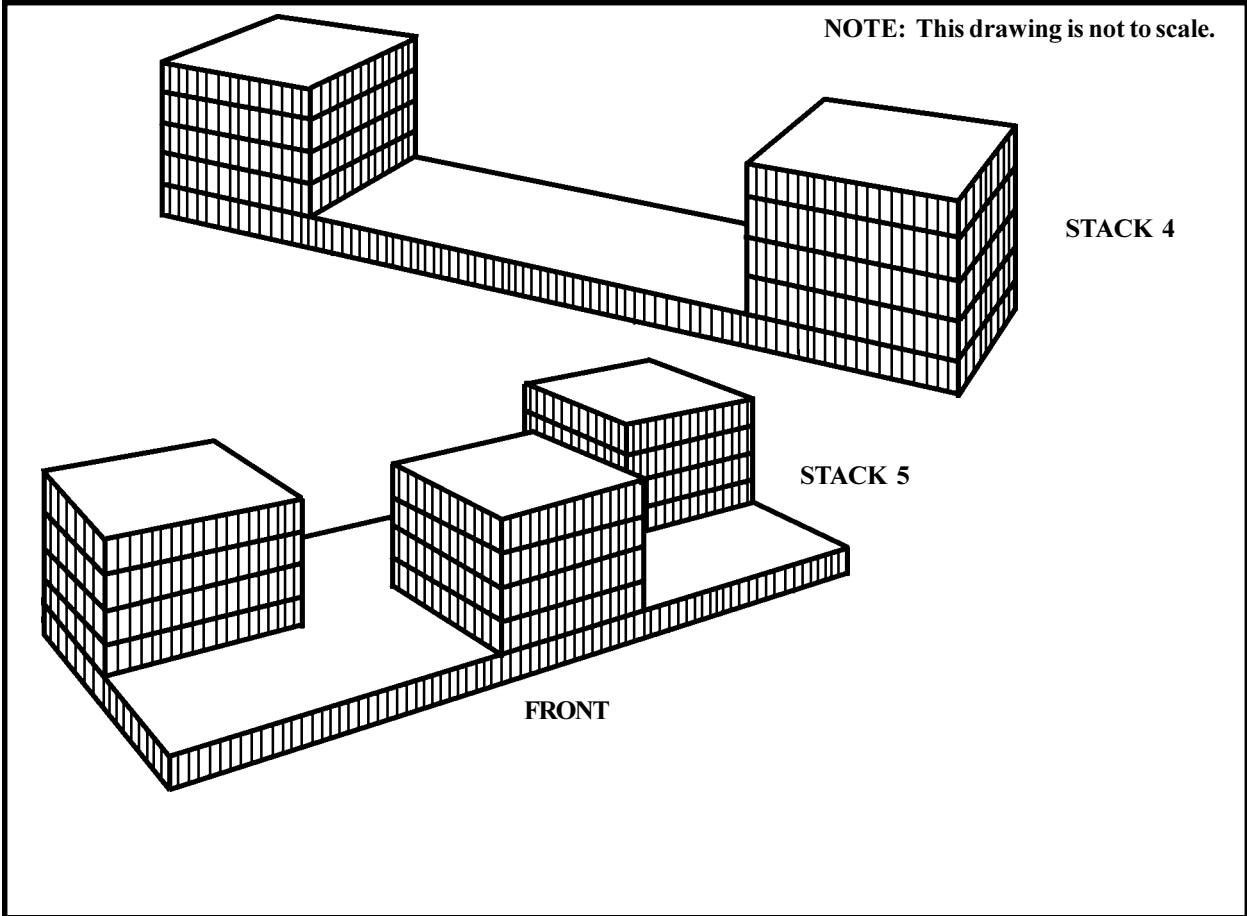

Stack Number	Pieces	Width (Inches)	Length (Inches)	Material	Instructions
4	1	72	16	Honeycomb	This is the base.
	8	16	16	Honeycomb	Glue four pieces flush with each end of the base.
5	1	72	36	Honeycomb	This is the base.
	4	16	16	Honeycomb	Center and glue flush with the front edge of the base
	8	18	18	Honeycomb	Glue four pieces flush with each rear corner of the base.

Figure 7-3. Stacks 4 and 5 prepared

NOTES: 1. All measurements are given in inches.
 2. This drawing is not to scale.

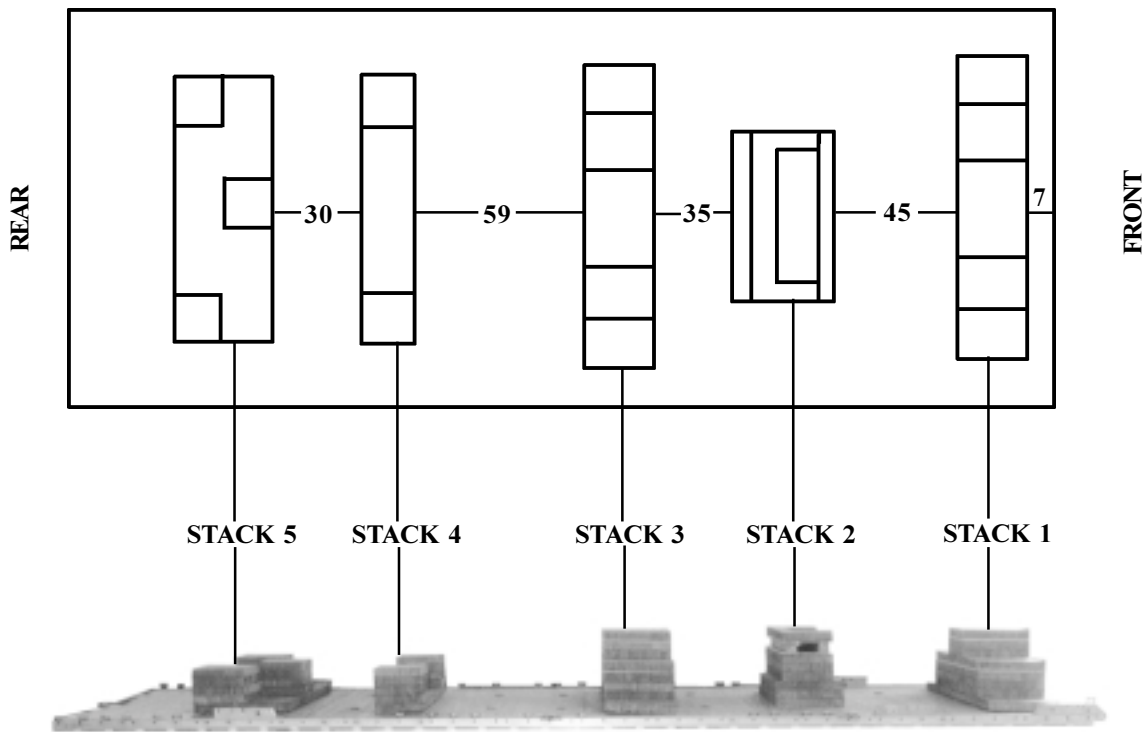

Stack Number	Position of Stack on Platform
1	Place stack: Centered 7 inches from the front of the platform.
2	Centered 45 inches from stack 1.
3	Centered 35 inches from stack 2.
4	Centered 59 inches from stack 3.
5	Centered 30 inches from stack 4.

Figure 7-4. Honeycomb stacks positioned on platform

NOTES: 1. All measurements are given in inches.
 2. This drawing is not to scale.

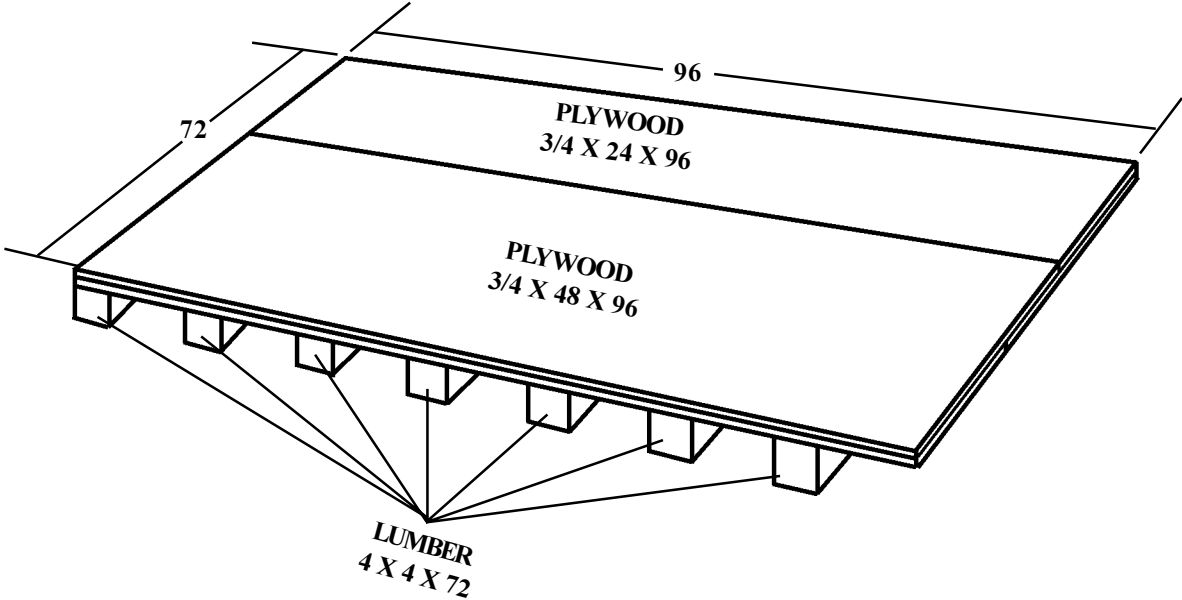

Strongback	Pieces	Width (Inches)	Length (Inches)	Material	Instructions
	2	48	96	3/4-in Plywood	Alternate pieces and nail plywood together forming a two layer 72-in x 96-in base.
	2	24	96	3/4-in Plywood	
	7	72		4-in x 4-in Lumber	Place a piece under the base flush with one end. place another under the base 12 inches from the opposite end. Space the remaining five pieces evenly between the first two pieces. Align all pieces with the outside edges of the base and nail each piece to the base through the plywood.

Figure 7-5. Strongback prepared

- NOTES:** 1. All measurements are given in inches.
 2. This drawing is not to scale.

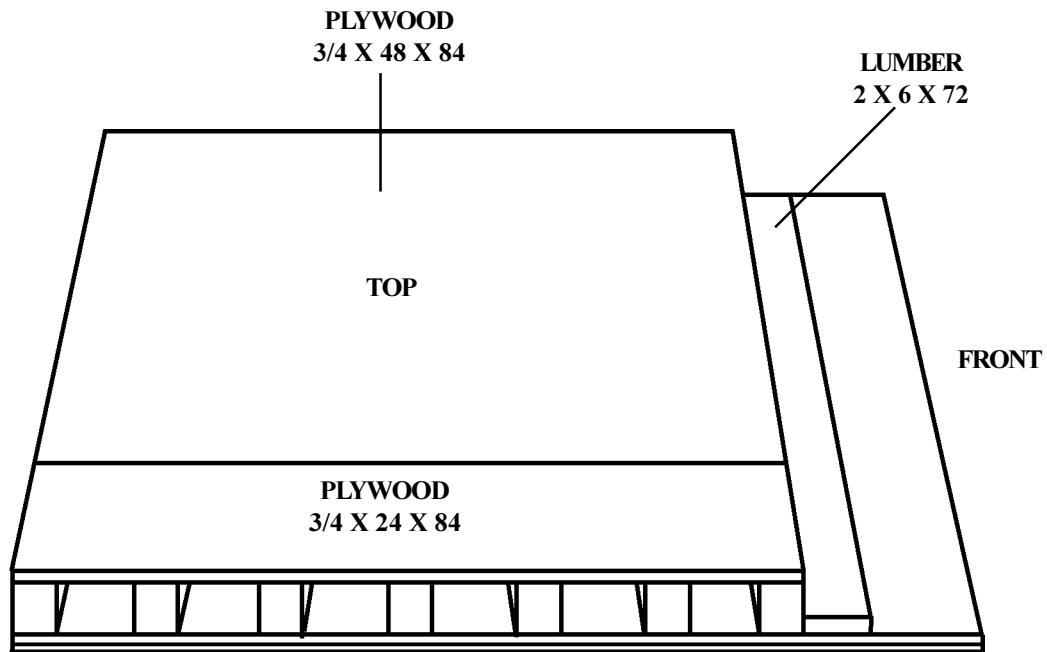

Strongback	Pieces	Width (Inches)	Length (Inches)	Material	Instructions
	1	48	84	3/4-in Plywood	Nail flush with lumber and base on left side.
	1	24	84	3/4-in Plywood	Nail flush with lumber and base on right side.
	1	72		2-in x 6-in Lumber	Nail to base flush against first piece of 4-in x 4-in lumber

Figure 7-5. Strongback prepared (continued)

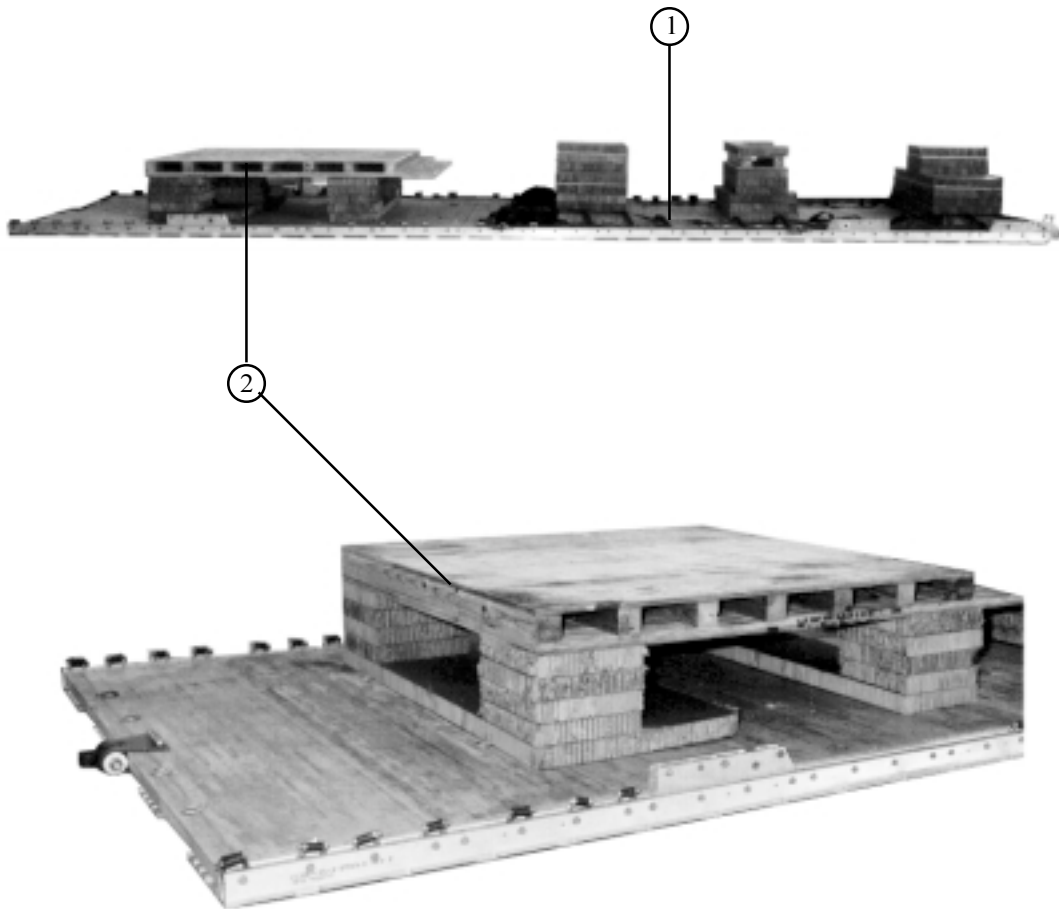

- ① Install the drive off aid using tie-down rings A1 and B1 according to FM 10-500-2/TO13C7-1-5. Extend the drive off aid toward the rear of the platform over the bottom layer of honeycomb on stacks 1 and 3.
- ② Set the strongback on stacks 4 and 5. Align the rear of the strongback with the rear of stack 5.

Figure 7-6. Strongback set on stacks 4 and 5 and drive off aid installed on platform

7-4. Preparing Truck

The Avenger turret must be removed from the truck before preparing the truck.

CAUTION

1. Allow only Avenger crew personnel to prepare the turret for removal.
2. Secure and account for the turret mounting bolts. Tape the bolts to the inside of the brass collection box.

Prepare the truck as outlined below:

a. Prepare the truck as described in paragraphs 2-4 a through c and paragraph 2-4d steps 2, 4, 5, 6, 7, 9, and 10, FM 10-517/TO 13C7-1-111.

b. Prepare the underside of the truck as shown in Figures 2-11 and 2-12 of FM 10-517/TO 13C7-1-111.

c. Further prepare the truck as shown in Figure 7-7.

WARNING

Remove all jewelry before working around electrical and mechanical equipment. Jewelry may conduct high voltage electricity resulting in serious injury.

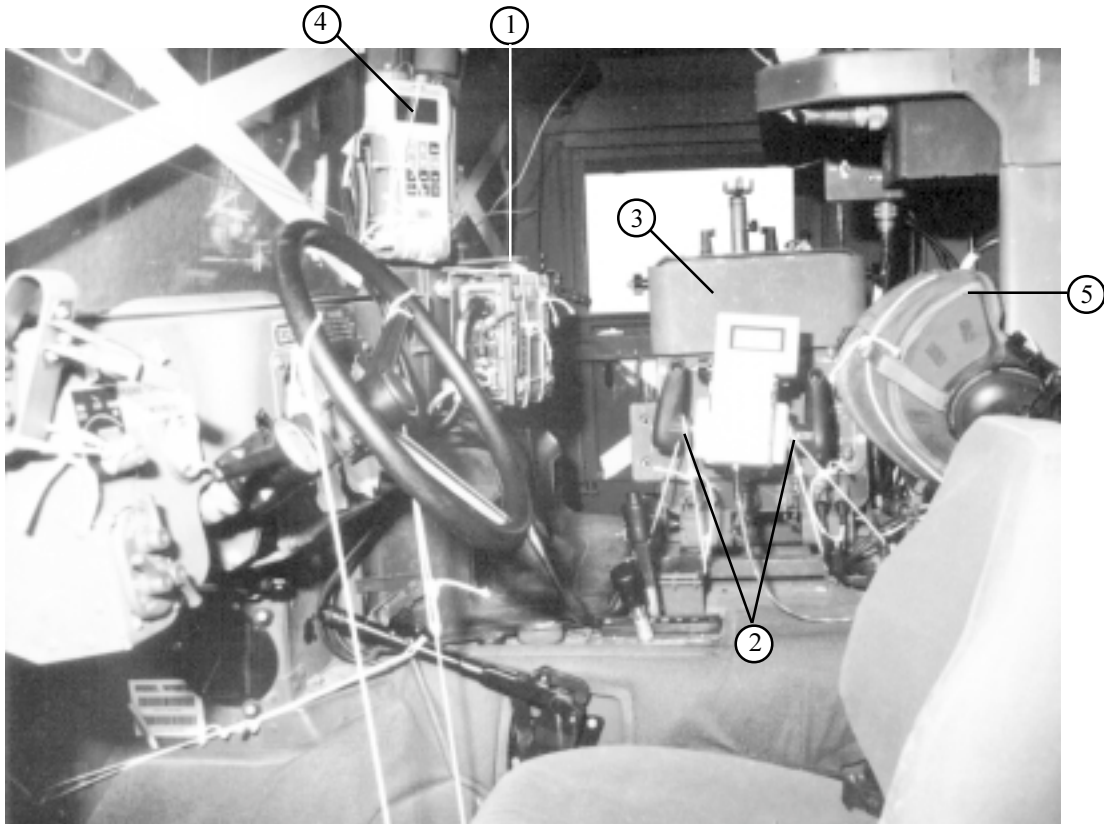

- ① Lower the sunshade on the targeting console and secure with type III nylon cord.
- ② Ensure the remote control unit is secured in place with the pins provided and safety tied on each side with type III nylon cord.
- ③ Lower the sunshade over the monitor.
- ④ Safety tie the Global Positioning System (GPS) in place with type III nylon cord.
- ⑤ Secure the driver's headset with type III nylon cord.
- ⑥ Secure the azimuth indicator and pointer assembly in place (if required) (not shown).
- ⑦ Safety tie the remote control cable to its bracket with type III nylon cord (if required) (not shown).

Figure 7-7. Truck prepared

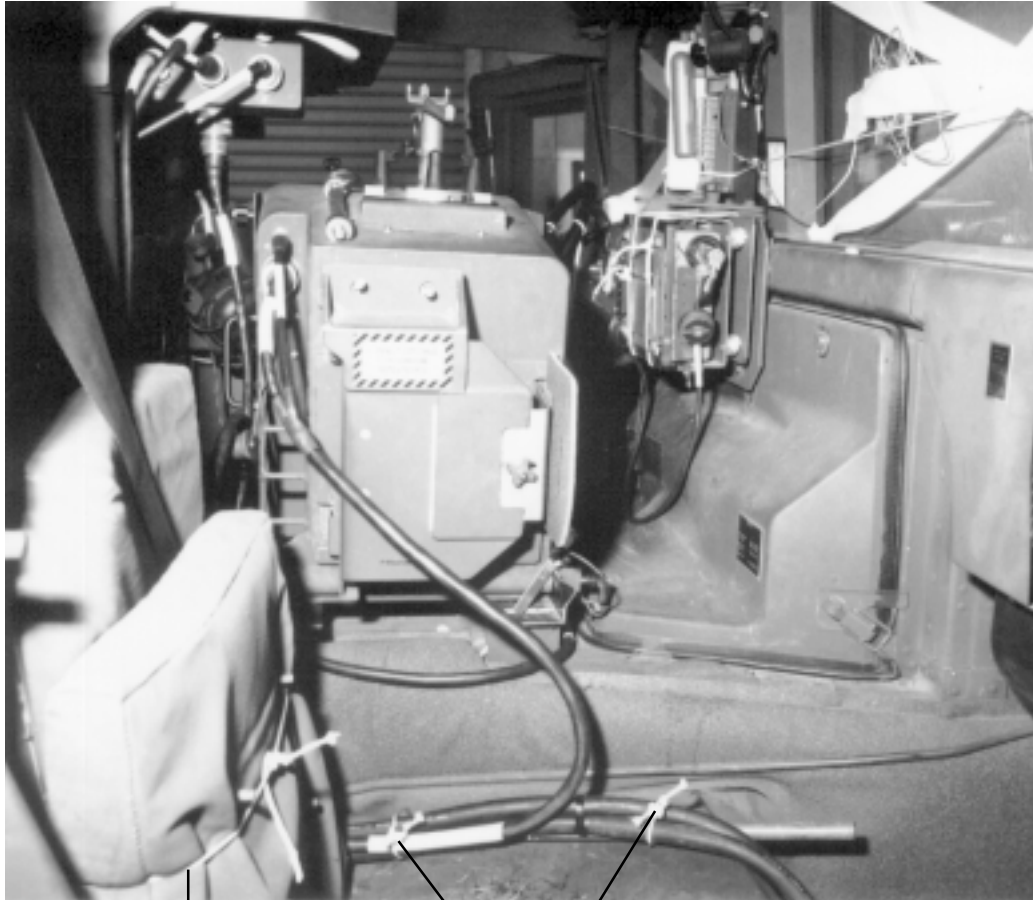

⑧

⑨

- ⑧ Fold up the seat bottom of the passenger's seat and secure it to the back of the seat with type III nylon cord.
- ⑨ Secure the slave cables and antennae to the passenger seat frame with type III nylon cord.

Figure 7-7. Truck prepared (continued)

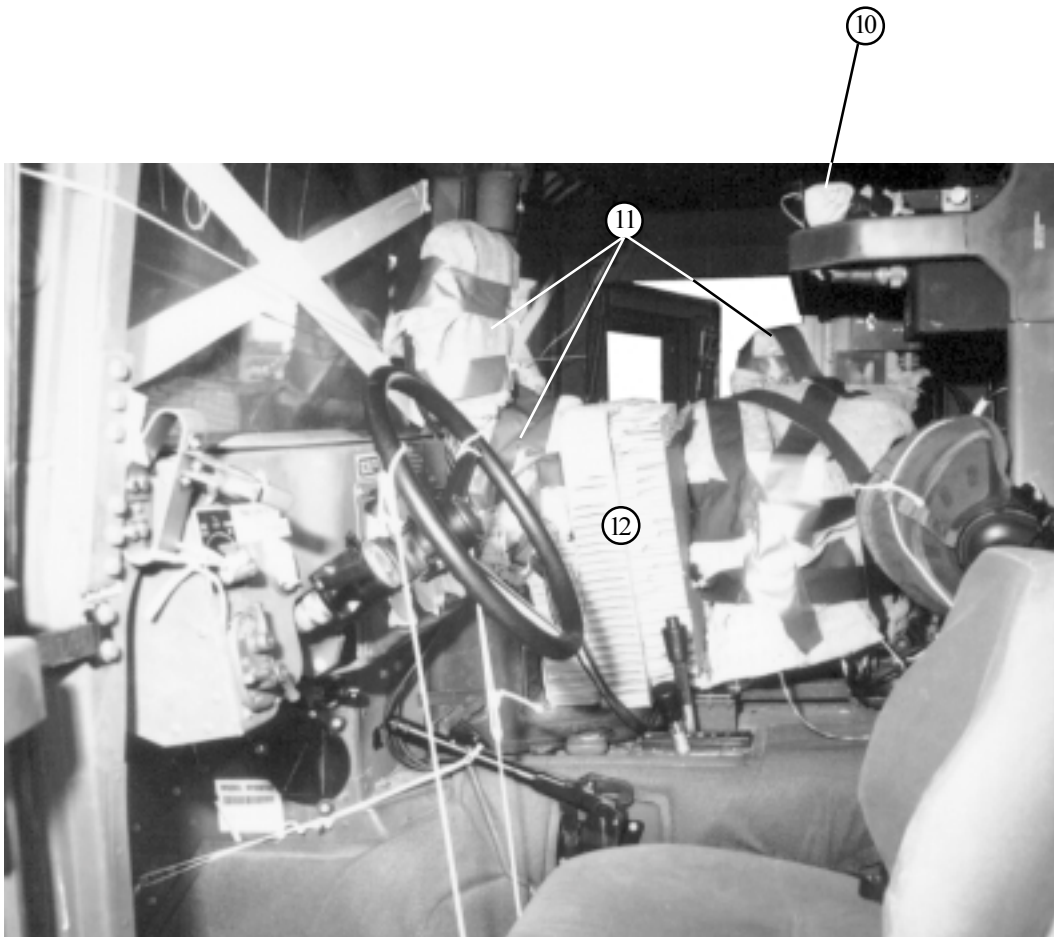

- ⑩ Secure the top mount radio with type III nylon cord. Wrap the radio with cellulose padding and secure the cellulose padding with tape.
- ⑪ Wrap the remote control unit, the targeting console, the GPS, and hand navigation system with cellulose padding. Secure the cellulose padding with tape.
- ⑫ Cut to fit and place honeycomb between the monitor and the targeting console.

Figure 7-7. Truck prepared (continued)

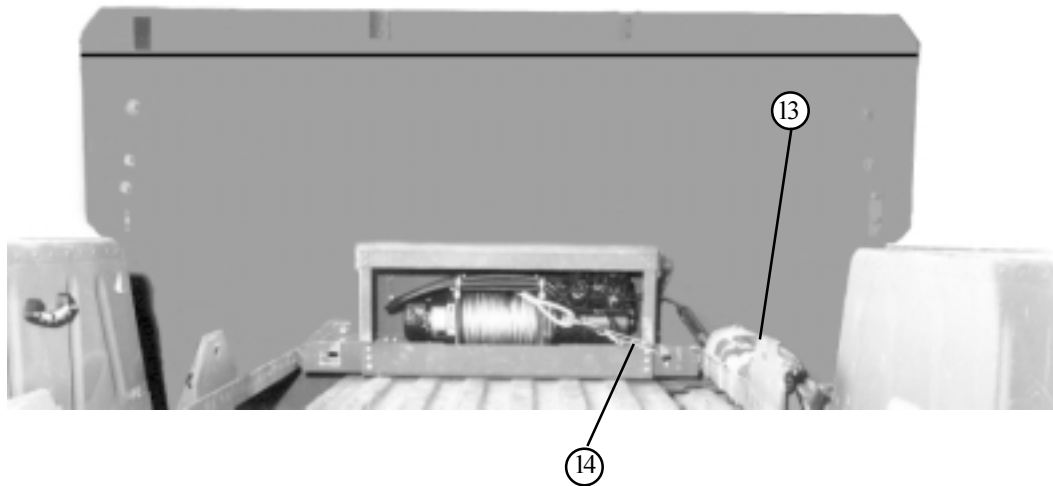

- ⑬ Wrap the control cables in the truck bed with cellulose padding and secure the cellulose padding with tape. Tie the wrapped cables to the turret frame with type III nylon cord.
- ⑭ Secure the winch cable to the winch frame with type III nylon cord.

Figure 7-7. Truck prepared (continued)

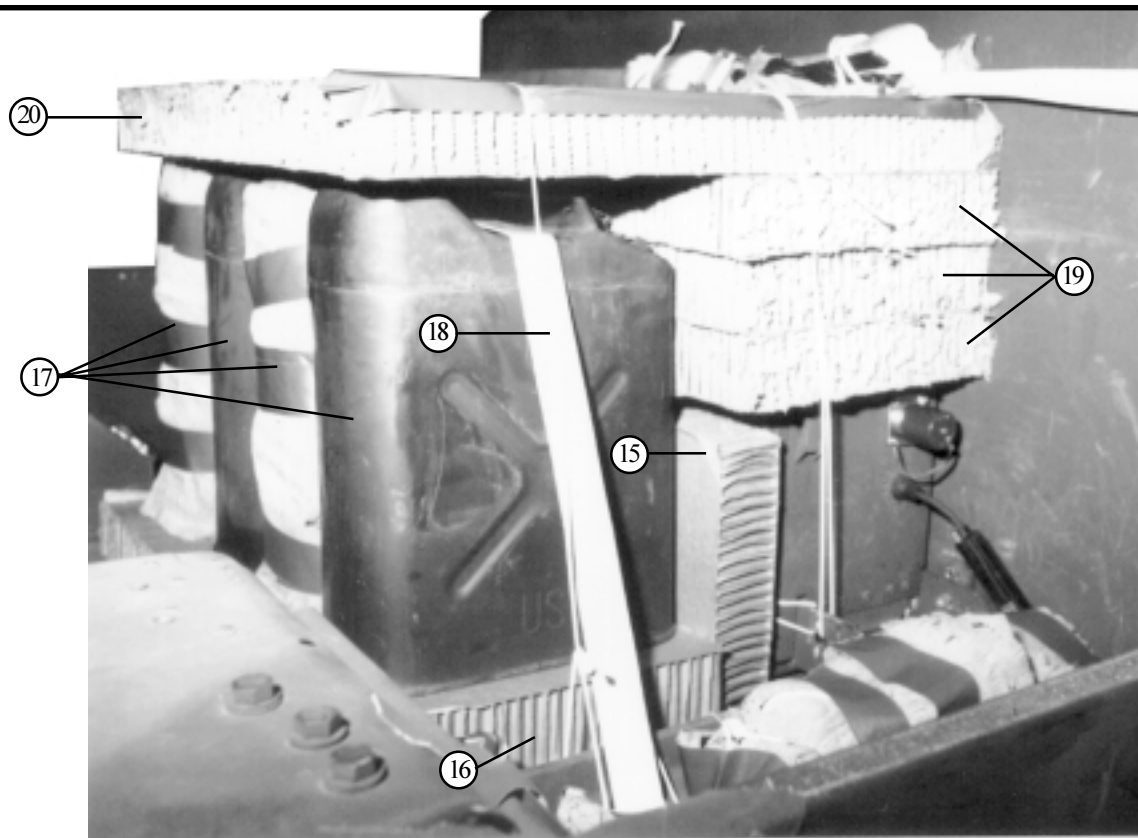

- ⑮ Place a 28- by 12-inch piece of honeycomb on edge against the winch frame (if rigging the Avenger w/o a winch frame, place a 40- by 13-inch piece of honeycomb on edge in front of the winch and tape the honeycomb to the cargo floor).
- ⑯ Place a 32- by 16-inch piece of honeycomb on the cargo floor in front of the honeycomb placed in step 15.
- ⑰ Pad two fuel cans with cellulose padding and secure the padding with tape. Alternate and place two fuel cans and two water cans flush on the honeycomb.
- ⑱ Pass a 15-foot lashing through the handles and under the rails of the turret frame on both sides. Close the load binder on one of the sides.
- ⑲ Place three 32- by 14-inch pieces of honeycomb on top of the winch in front of the cans (use 40- by 12-inch pieces for the Avenger w/o winch frame).
- ⑳ Place a 32- by 28-inch piece of honeycomb on top of the cans and honeycomb placed in step 19. Tape the side edges of the honeycomb. Secure the honeycomb with two lengths of type III nylon cord to the turret frame.

Note: When rigging the Avenger w/o winch frame, place a piece of honeycomb on each side of the winch.

Figure 7-7. Truck prepared (continued)

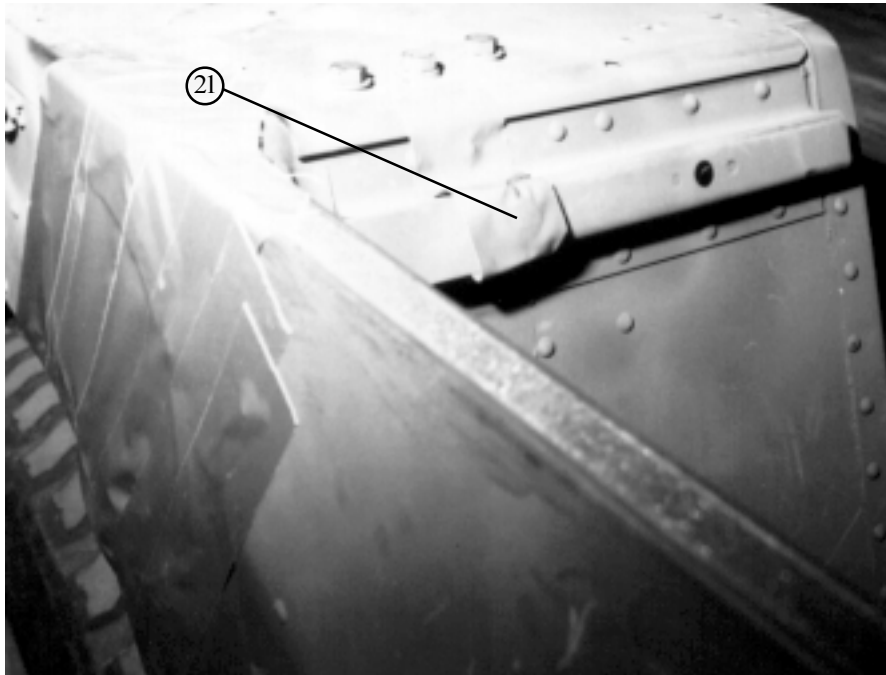

- ②① Secure the rear door pins with tape.
- ②② Place the camouflage net bag against the cans. Tie the net bag to the rails with three lengths of type III nylon cord (if required) (not shown).
- ②③ Tape all lights and reflectors (not shown).

Figure 7-7. Truck prepared (continued)

NOTES: 1. All measurements are given in inches.
2. This drawing is not to scale.

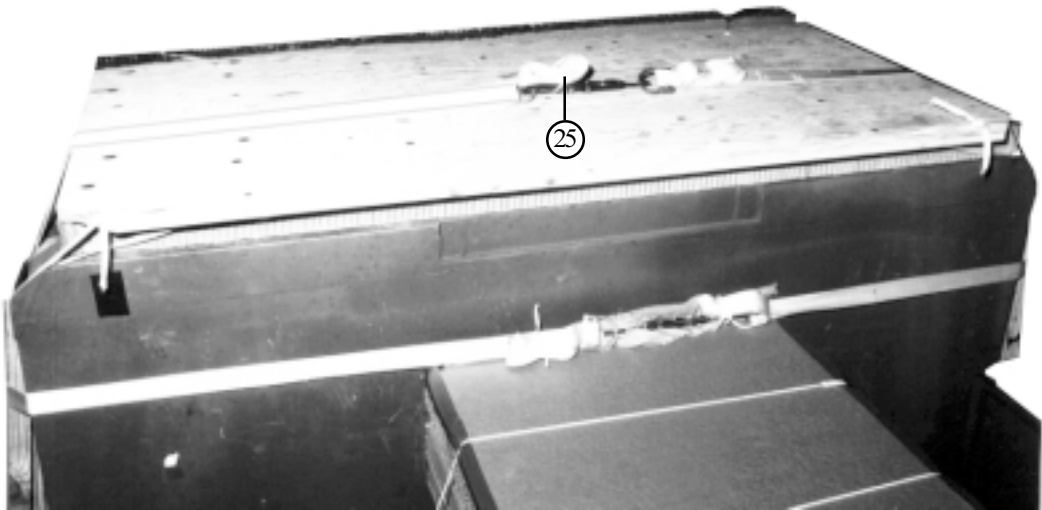
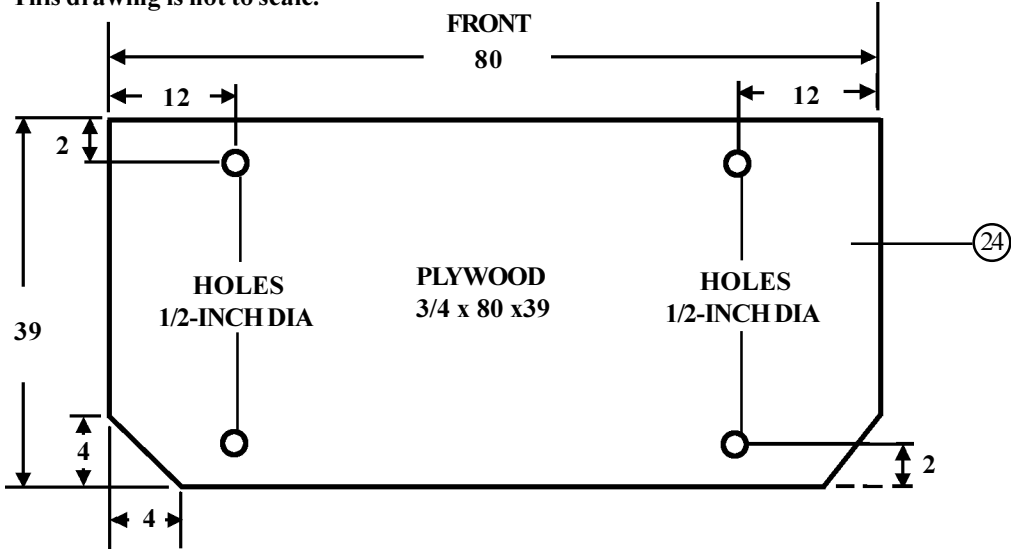

- (24) Fabricate a roof protector by making cuts and 1/2-inch holes as shown in an 80- by 39-inch piece of 3/4-inch plywood. Glue an 80- by 36-inch piece of honeycomb to the plywood, flush along the front edge.
- (25) Place the roof protector on the roof, honeycomb side down as shown. Route a 30-foot lashing through the open windows and under the radio mount. Close the load binder on top of the roof protector.

Figure 7-7. Truck prepared (continued)

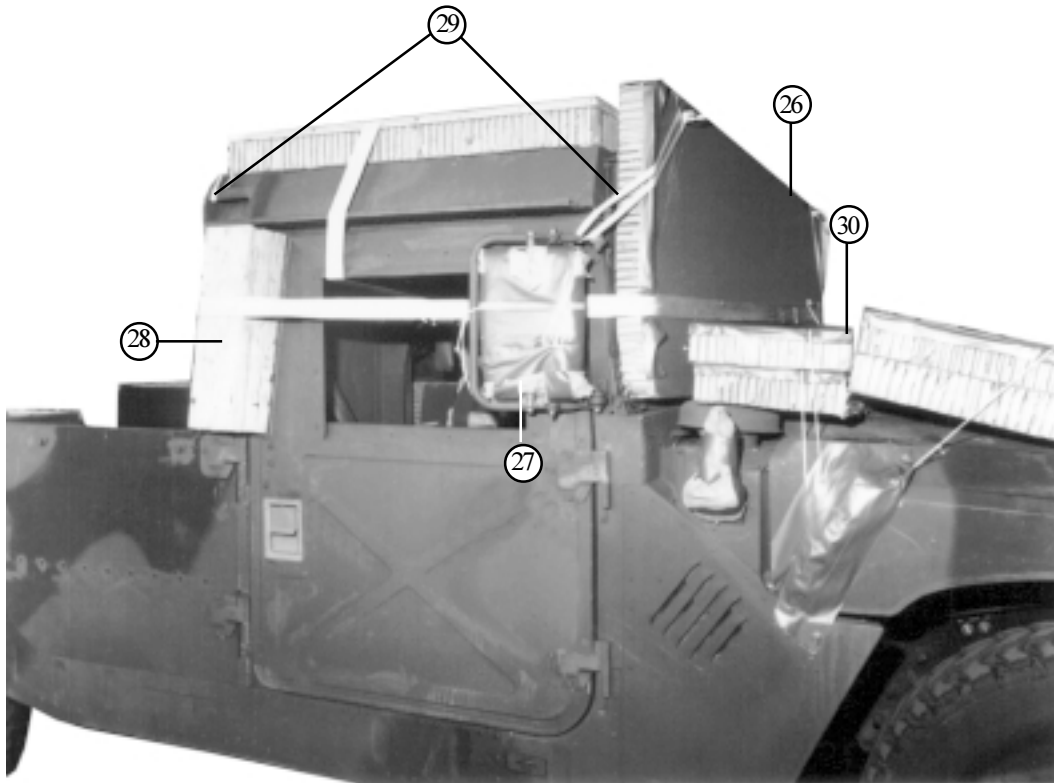

- ②⑥ Place an 83- by 23-inch piece of honeycomb against the windshield and tape the outside edges.
- ②⑦ Pad the mirrors with cellulose padding and secure the padding with tape. Fold the mirrors to the side.
- ②⑧ Make two spacers each of three pieces of 2- by 8- by 18-inch lumber and a layer of 10- by 22-inch felt. Nail the lumber together and glue the felt to one side of the spacer. Place a spacer vertically behind each door window. Route a 30-foot lashing around the windshield, through the mirror brackets, over the spacers, and close the load binder behind the cab.
- ②⑨ Tie the front of the roof protector to the mirror brackets by routing a length of 1/2-inch tubular nylon webbing through the 1/2-inch hole in the roof protector and around the mirror bracket. Tie the rear of the roof protector to the handles on the roof by routing a length of 1/2-inch tubular nylon webbing through the rear holes of the roof protector and around the roof handle.
- ③⑩ Cut two 82- by 12-inch pieces of honeycomb and tape the 12-inch edges. Tie the two pieces of honeycomb to the hood in front of the honeycomb covering the windshield with a length of type III nylon cord.

Figure 7-7. Truck prepared (continued)

NOTES: 1. All measurements are given in inches.
2. This drawing is not to scale.

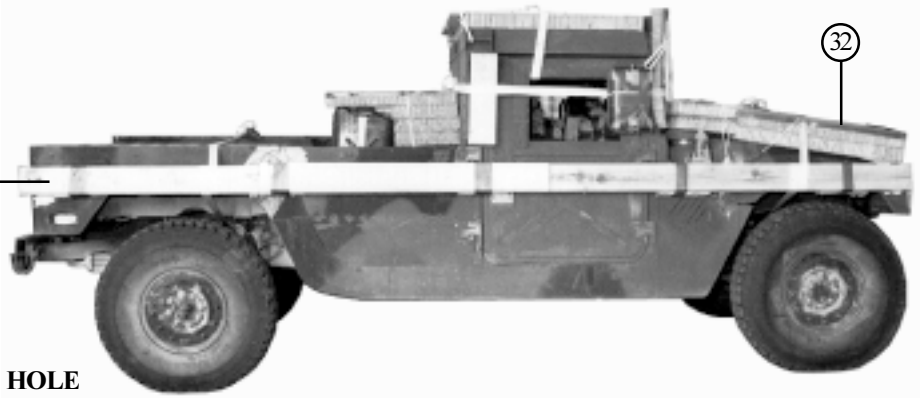
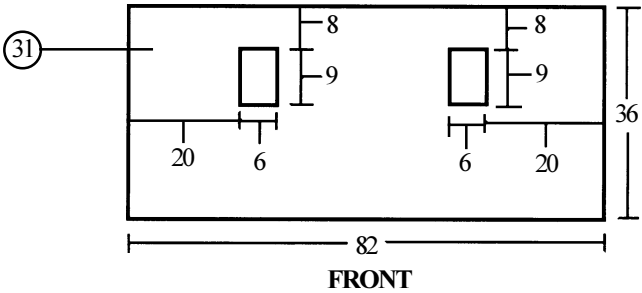

1/2-DIA HOLE
2-INCHES FROM
END

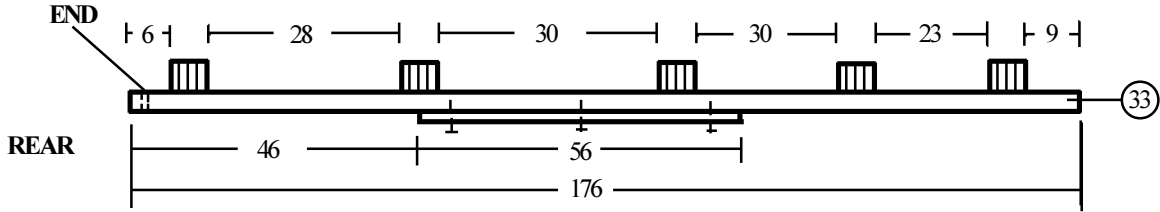

- ① Make cutouts as shown above in two 82- by 36-inch pieces of honeycomb and tape the outside edges.
- ② Tie the honeycomb over the hood with type III nylon cord. Make two ties front to rear and two ties side to side. Tape the hood latches.
- ③ Fabricate two side boards by nailing a 2- by 6- by 56-inch piece of lumber flush with and 46 inches from the rear edge of a 2- by 6- by 176- inch piece of lumber. Glue five 5 1/2- by 10-inch pieces of honeycomb to the other side of the 176-inch piece, spaced as shown. Drill a 1/2-inch hole, centered and 2 inches from the rear of the board.
- ④ Secure the side boards to each side of the truck as shown in Figure 2-13, FM 10-517/TO 13C7-1-111.

Figure 7-7. Truck prepared (continued)

7-5. Preparing Turret

Prepare the turret as shown in Figure 7-8.

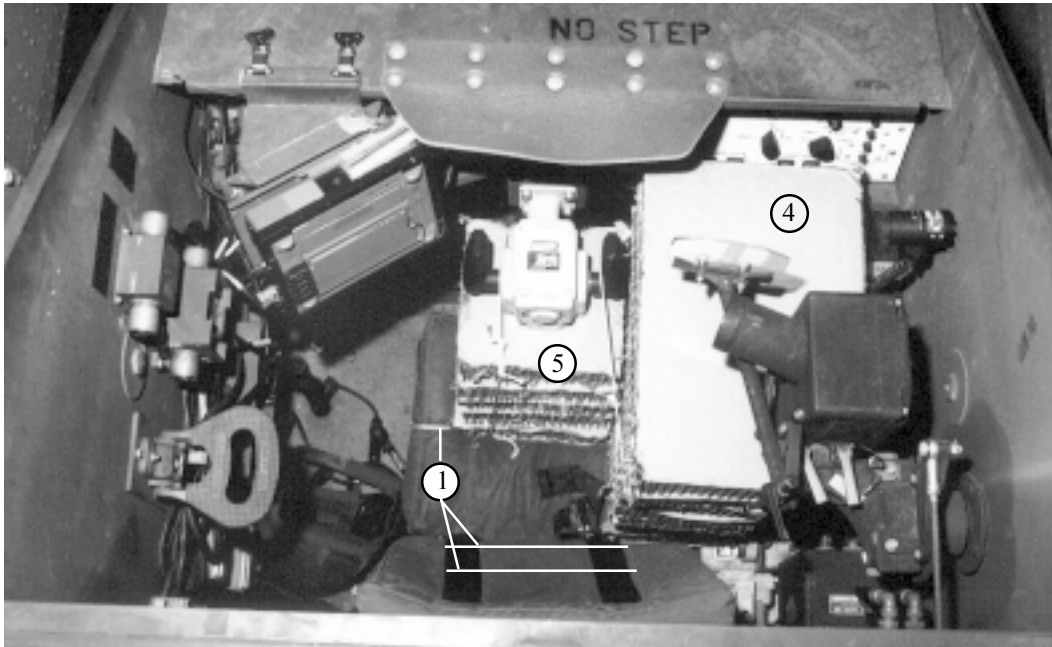

- ① Tie the seat and seat back to the seat frame with type III nylon cord.
- ② Remove the azimuth and elevation pins and place them in the clips provided (on older, unmodified turrets) (not shown).
- ③ Remove the pins from the optical sight bracket and lift the sight to the side (not shown).
- ④ Cut ten 12- by 18-inch pieces of honeycomb with a 4- by 4-inch cutout in one corner and glue the pieces together. Cut two 3/4- by 8- by 8-inch pieces of plywood with a 4- by 4-inch cutout in one corner. Align the cutouts and nail the plywood together. Align the cutouts and glue the plywood on top of the honeycomb. Place the honeycomb and plywood stack under the optical sight and against the control panel. Secure the optical sight in the bracket with the pins. Secure the stack with type III nylon cord (the older, unmodified turret requires eight 12- by-18-inch pieces of honeycomb with no cutouts or plywood).
- ⑤ Glue together five 10- by 10-inch pieces of honeycomb. Place the stack under the hand station and secure in place with type III nylon cord.

Figure 7-8. Turret prepared

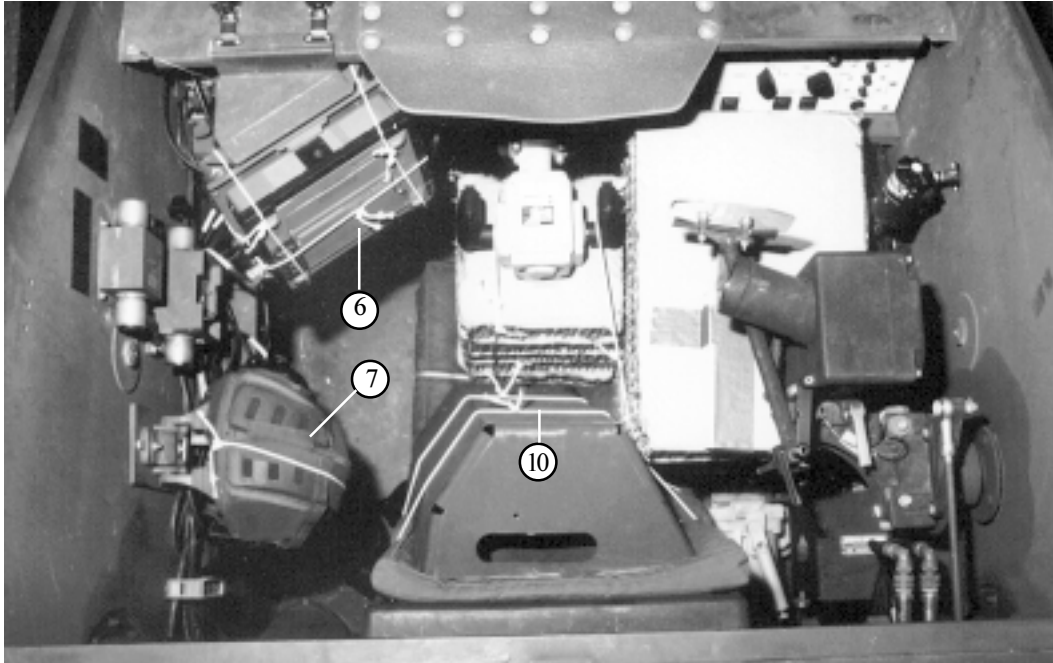

- ⑥ Secure the control display terminal in its bracket with type III nylon cord.
- ⑦ Secure the operator's headset with type III nylon cord.
- ⑧ Remove the flash suppressor and the brass collection tray from the 50-caliber machine gun (not shown).
- ⑨ Tape the turret mounting bolts inside the brass collection tray. Pad the flash suppressor with cellulose padding and tie to the inside of the tray with type III nylon cord (not shown).
- ⑩ Secure the brass collection tray to the seat with two lengths of type III nylon cord.
- ⑪ Secure all loose cables and objects with type III nylon cord (not shown).
- ⑫ Close the canopy and install the road cover if available (not shown).

Figure 7-8. Turret prepared (continued)

7-6. Positioning Truck on Platform and Installing the Drive Off Aid

Position the truck on the platform and install the drive off aid as shown in Figure 7-9.

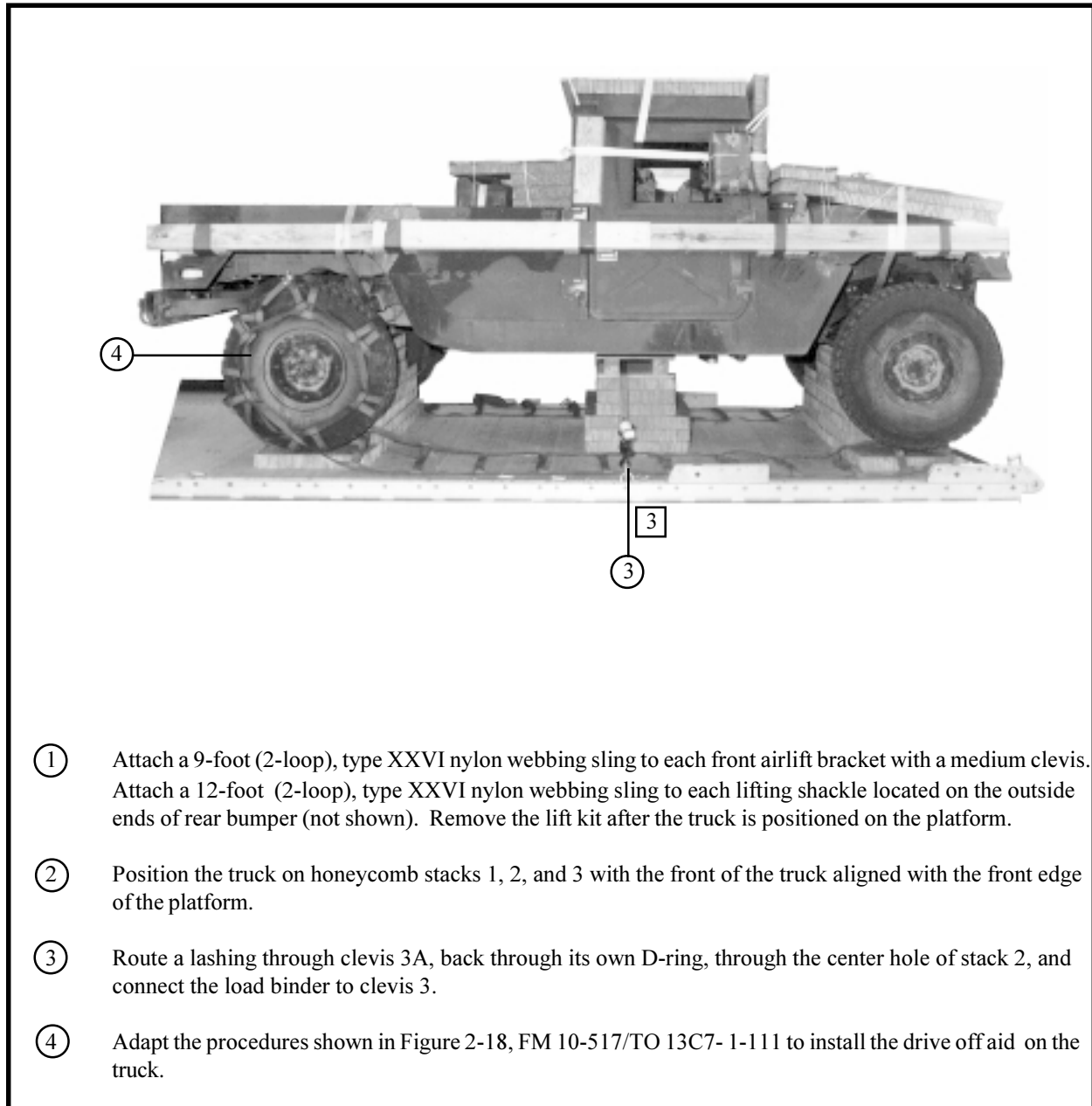
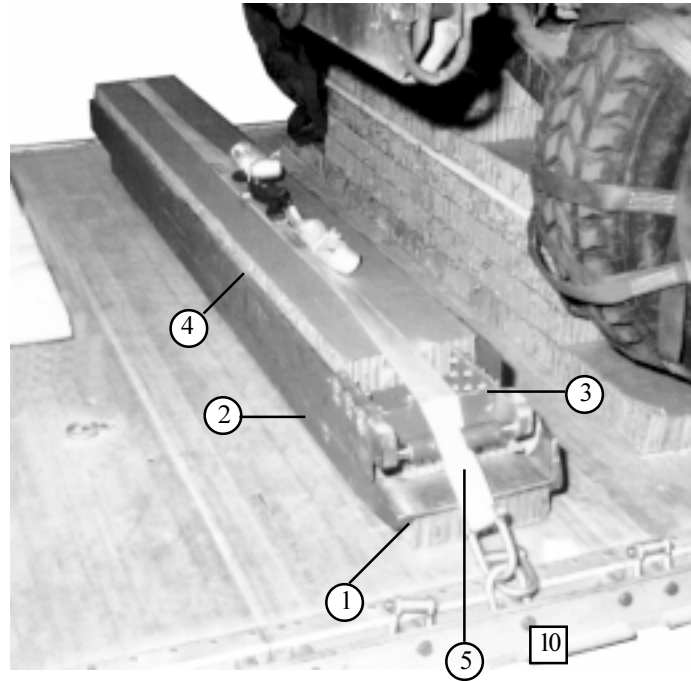

Figure 7-9. Truck positioned and drive off aid installed

7-7. Lashing Ramps to Platform

Lash the ramps used for mounting the Avenger turret as shown in Figure 7-10.



- ① Center an 80- by 10-inch piece of honeycomb between clevises 10 and 10A.
- ② Place one ramp over the honeycomb. Place a second 80-by 10-inch piece of honeycomb on top of the ramp.
- ③ Place the second ramp on top of the honeycomb placed in step 2 with the roller facing the opposite way from the roller of the first ramp.
- ④ Place an 80- by 10-inch piece of honeycomb on top of the second ramp.
- ⑤ Route a 30-foot lashing through clevis 10, through the roller, over the honeycomb and ramps, through the roller on the opposite side, and through clevis 10A. Close the load binder on top of the honeycomb and ramps.

Figure 7-10. Ramps lashed to platform

7-8. Lashing Truck

Lash the truck to the platform according to FM 10-500-2/TO 13C7-1-5 and route the lashings as shown in Figure 7-11.

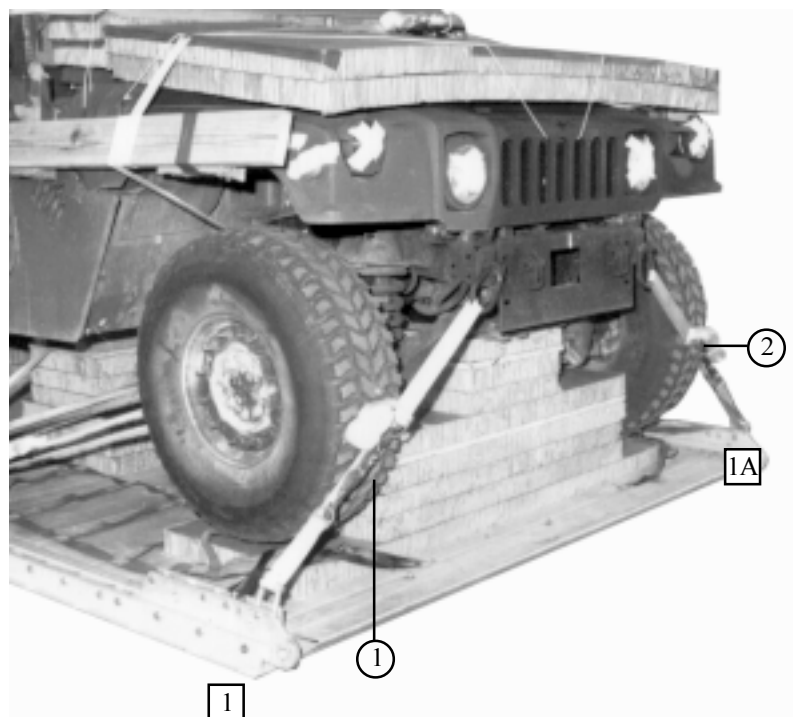

Lashing Number	Tiedown Clevis Number	Instructions
1	1	Pass lashing: Through front truck tie-down, right side.
2	1A	Through front truck tie-down, left side.

Figure 7-11. Truck lashed to platform

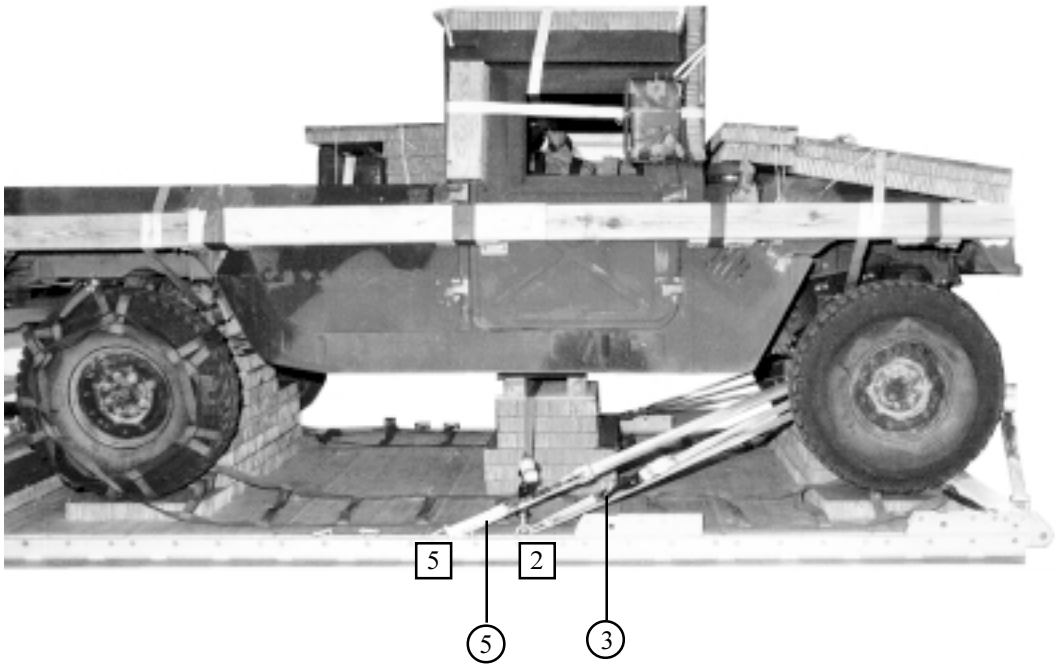

Lashing Number	Tiedown Clevis Number	Instructions
3	2	Pass lashing: Around lower front control arm, right side.
4	2A	Around lower front control arm, left side.
5	5	To tie-down bracket behind front coil spring, right side.
6	5A	To tie-down bracket behind front coil spring, left side.

Figure 7-11. Truck lashed to platform (continued)

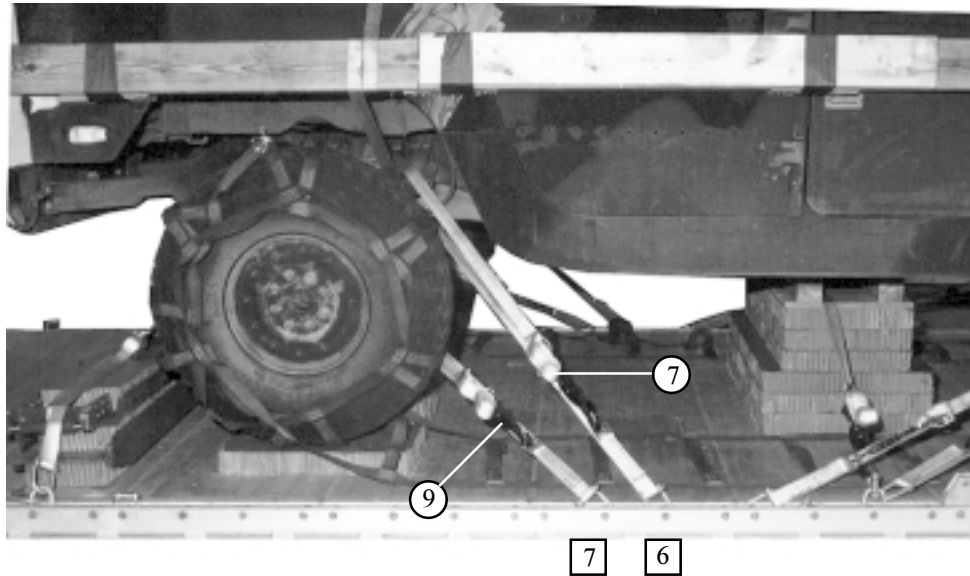

Lashing Number	Tiedown Clevis Number	Instructions
7	6	Pass lashing: Through tie-down bracket in front of rear coil spring, right side.
8	6A	Through tie-down bracket in front of rear coil spring, left side.
9	7	Around rear lower control arm, right side.
10	7A	Around rear lower control arm, left side.

Figure 7-11. Truck lashed to platform (continued)

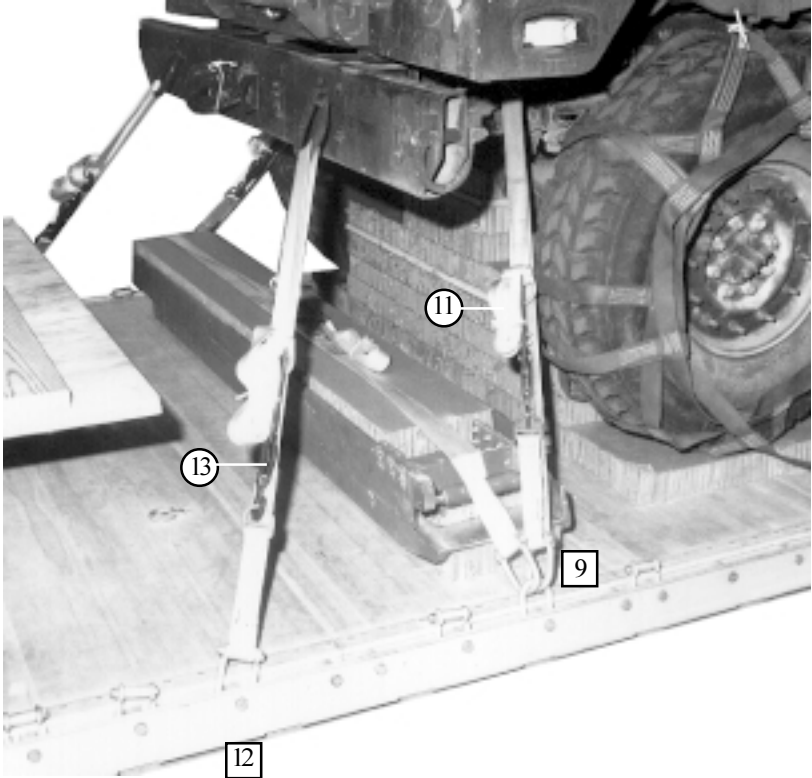

Lashing Number	Tiedown Clevis Number	Instructions
11	9	Pass lashing: Through tie-down bracket behind the rear coil spring, right side.
12	9A	Through tie-down bracket behind the rear coil spring, left side.
13	12	Through rear truck tie-down, right side.
14	12A	Through rear truck tie-down, left side.

Figure 7-11. Truck lashed to platform (continued)

7-9. Positioning and Preparing the Turret on the Platform

Position and prepare the turret on the platform as shown in Figure 7-12.

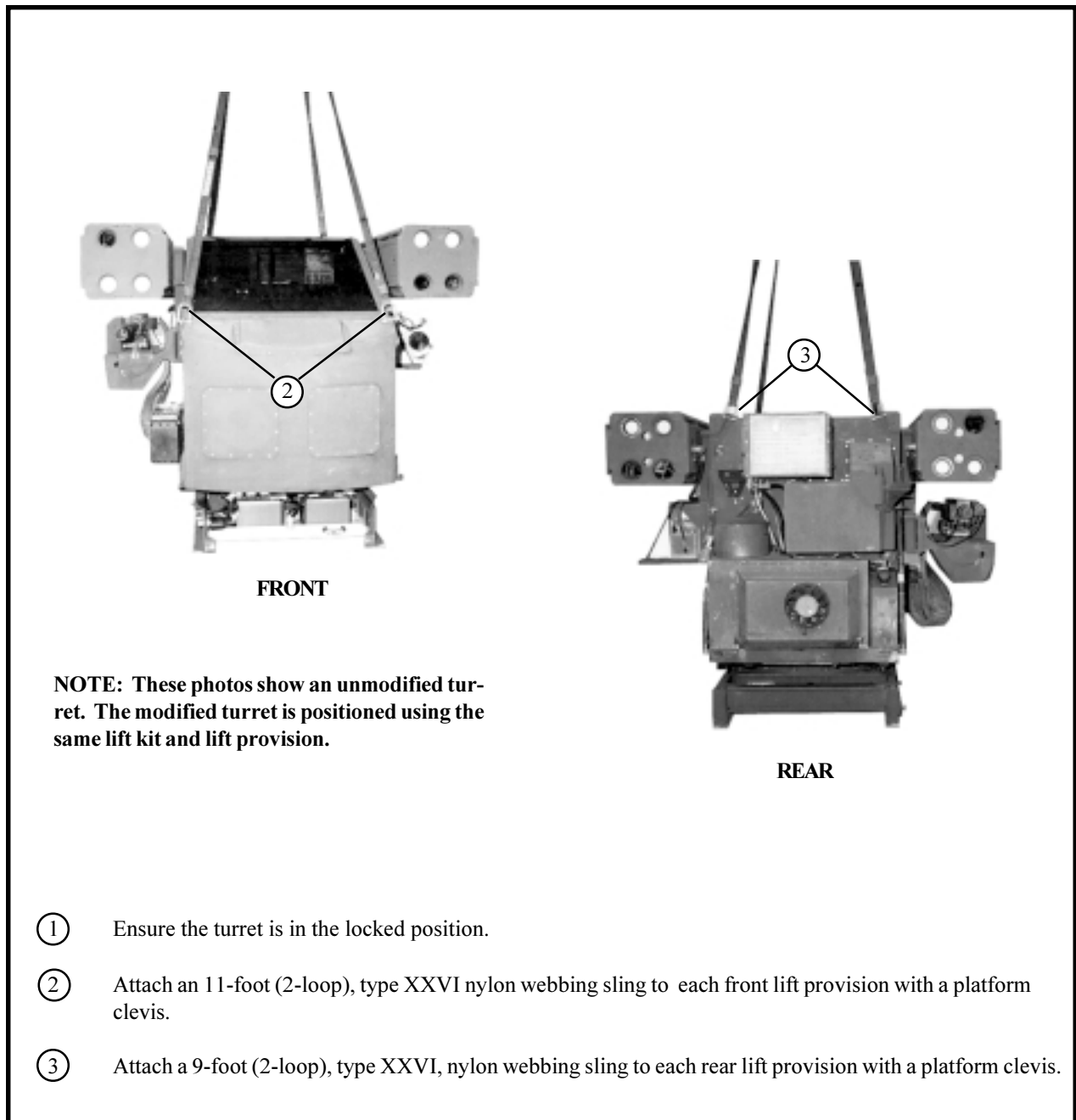
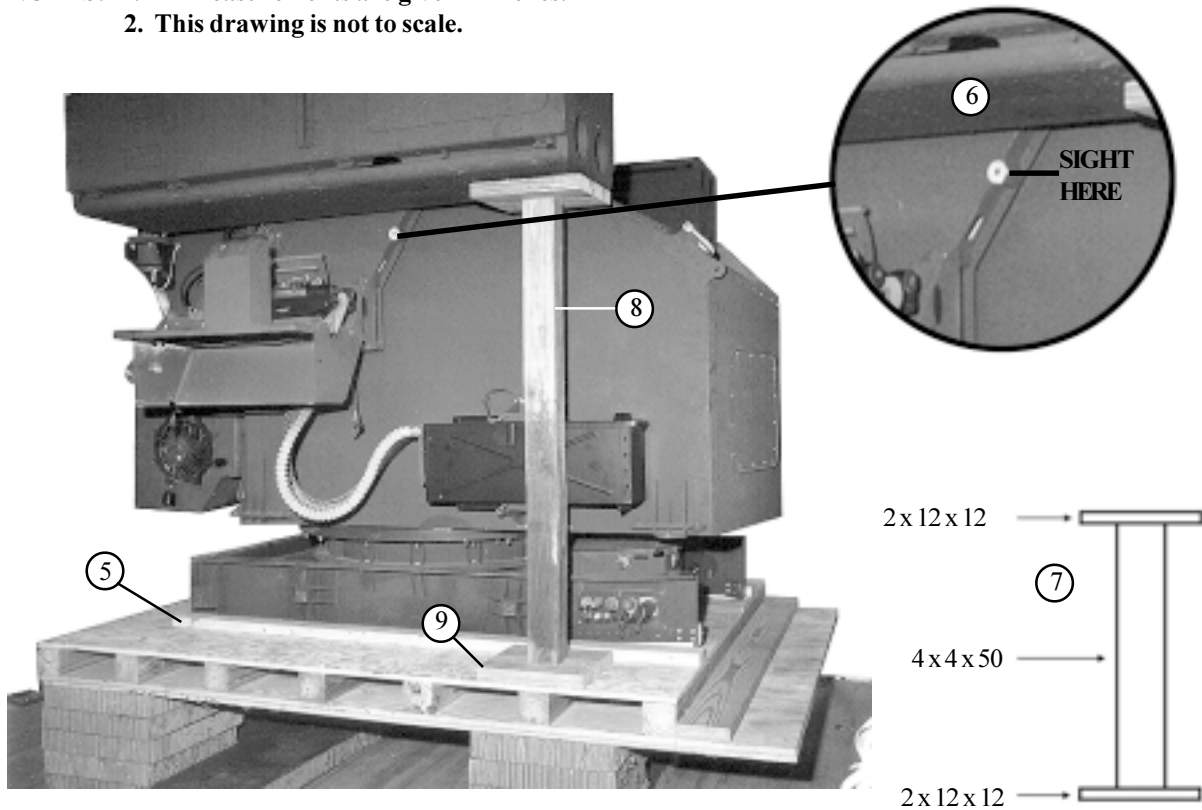

Figure 7-12. Turret positioned and prepared

- NOTES:** 1. All measurements are given in inches.
2. This drawing is not to scale.



- ④ Position the turret facing forward, centered and one inch from the forward edge of the strongback. Remove the lift kit and leave the platform clevises on the front lift points of the turret.
- ⑤ Nail a 2- by 4- by 73-inch piece of lumber to the top of the strongback flush along each side of the weapon system mount.
- ⑥ Ensure the system is at mechanical zero by sighting through the silver colored metal hole on the exterior of the turret. If the exterior hole and the interior hole are aligned you can see either the inside wall of the turret or the locking pin protruding through the two holes. Either situation achieves mechanical zero.
- ⑦ Build two missile pod supports as shown above.
- ⑧ Place a support under each missile pod. Align the front edge of the support with the front edge of the pod. Align the outside edges of the supports with the outside edges of the strongback.
- ⑨ Nail the bottom of the pod supports to the load spreader. Drive a nail through each corner of the support bottoms and bend the nails under the top layer of plywood.

Figure 7-12. Turret positioned and prepared (continued)

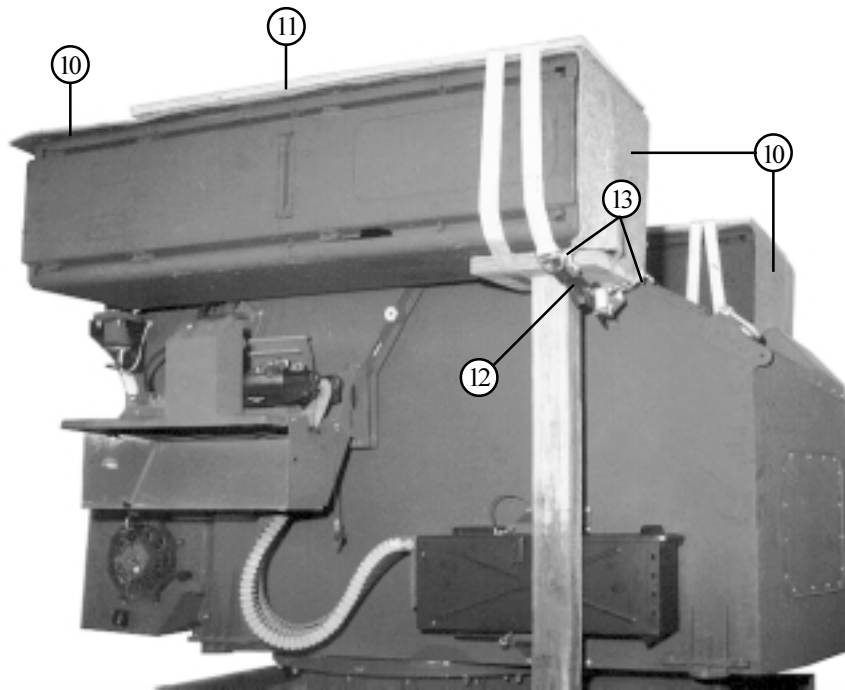

- ⑩ Place an 80- by 18-inch piece of 1/2-inch felt over each pod, extending the front edge of the 1/2-inch felt down to the front lower edge of of the pod.
- ⑪ Place a 3/4- by 18- by 48-inch piece of plywood over the 1/2-inch felt on each pod. Align the front edge of the plywood with the front edge of the pod.
- ⑫ Beginning at the front inside edge of each pod support, wrap a 15-foot lashing over the pod and behind the support upright. Pass the lashing over the pod and secure it so the load binder is in front of the upright and under the top piece of the support.
- ⑬ Punch a hole in each front corner of the 1/2-inch felt placed in step 10 above. Tie the front corners of the 1/2-inch felt to the D-rings on the lashings with type III nylon cord.

Figure 7-12. Turret positioned and prepared (continued)

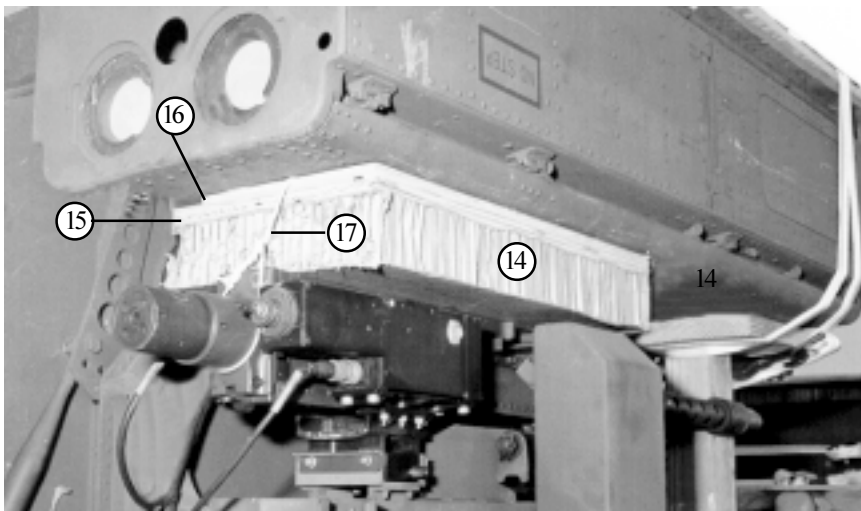
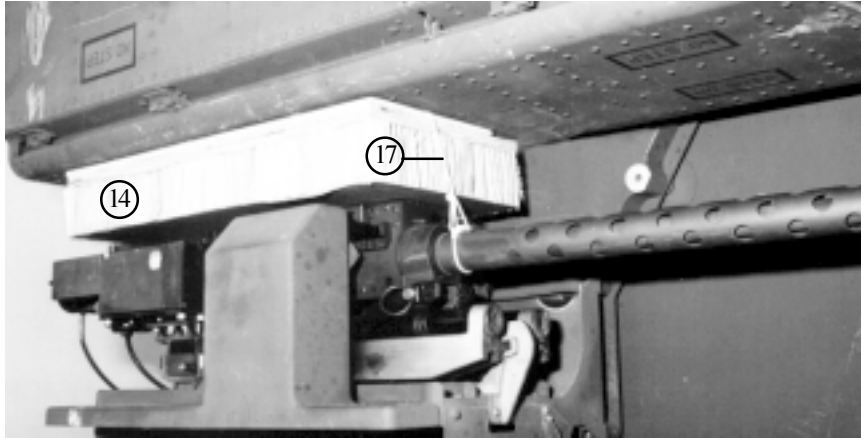

- ⑭ Center a 24- by 12-inch piece of honeycomb on top of the gun.
- ⑮ Place a 24- by 12- by 3/4-inch piece of plywood flush on the honeycomb.
- ⑯ Place a 24- by 9 1/2- by 1/4-inch piece of plywood over the plywood placed in step 15 above. Place this piece flush with the outside edges of the other pieces.
- ⑰ Secure these pieces to the gun with type III nylon cord.

Figure 7-12. Turret positioned and prepared (continued)

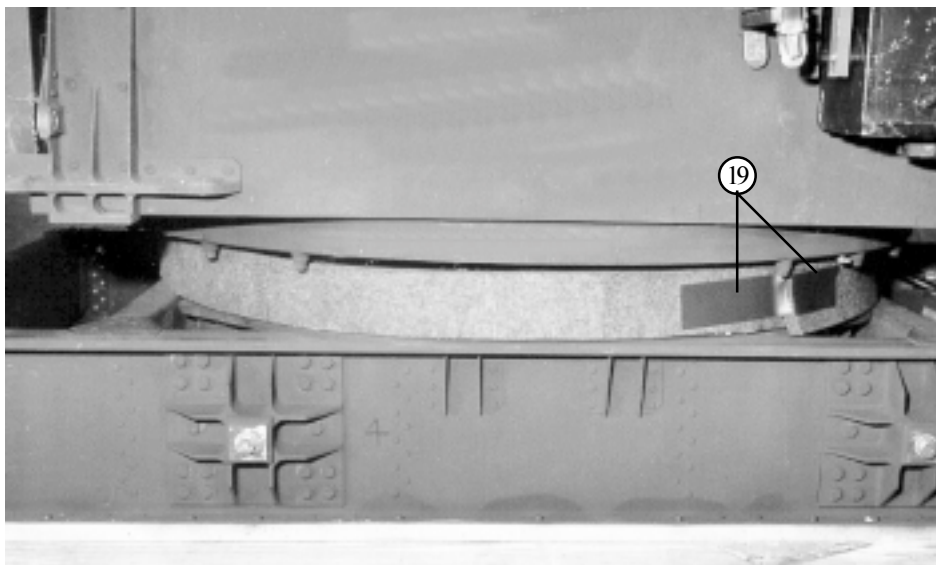
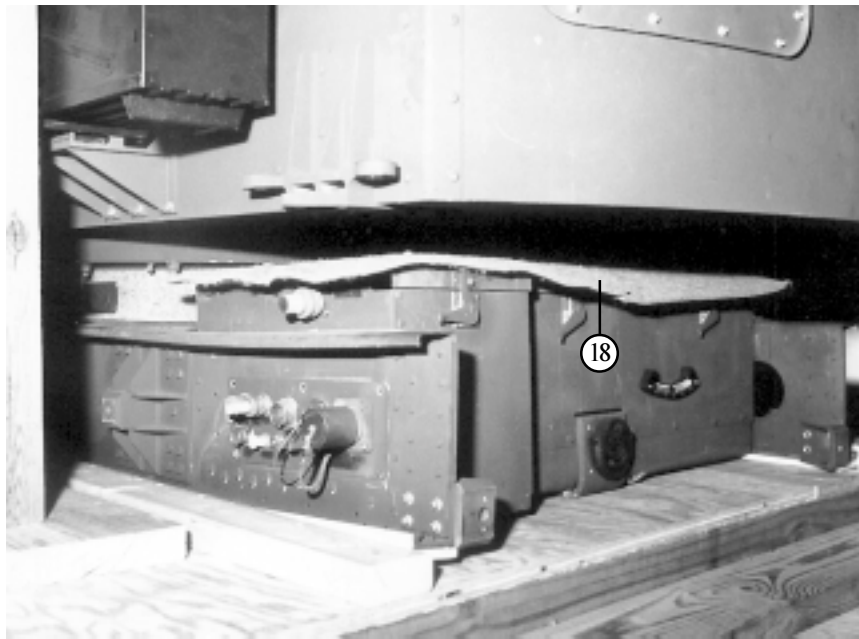

- ⑱ Cover the battery case with a 16- by 34-inch piece of 1/2-inch felt.
- ⑲ Pad the turret base with three 3- by 48-inch pieces of 1/2-inch felt. Overlap and tape the pieces in place.

Figure 7-12. Turret positioned and prepared (continued)

7-10. Lashing Turret

Lash the turret to the platform according to FM 10-500-2/ TO 13C7-1-5 and as shown in Figure 7-13. Lash the turret to the strongback as shown in Figure 7-14.

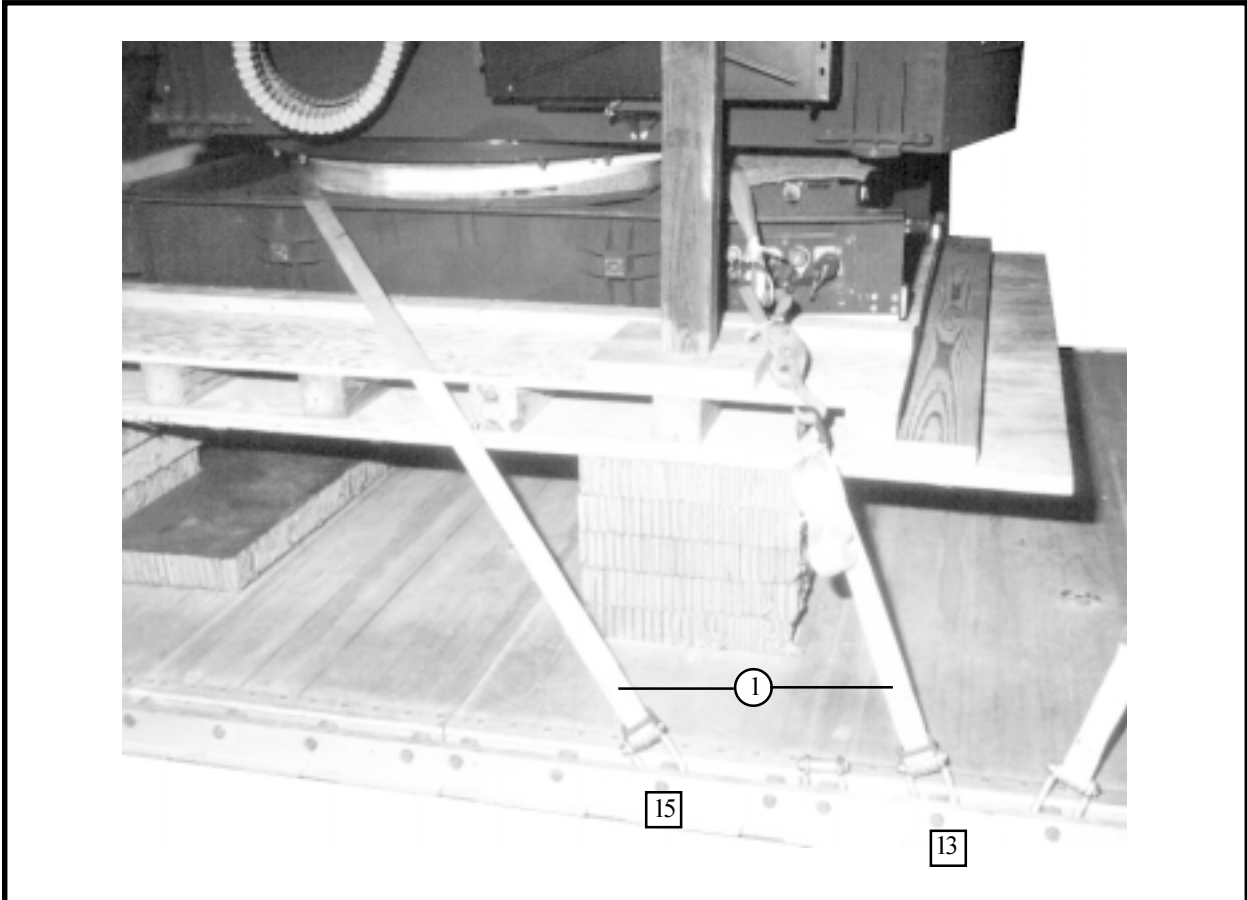

Lashing Number	Tiedown Clevis Number	Instructions
1	13 and 15	Pass a 15-foot lashing through each clevis and through its own D-ring. Pass the lashing from clevis 15 around the padded turret base. Secure both lashings together with two D-rings and a load binder.
2	13A and 15A	Pass a 15-foot lashing through each clevis and through its own D-ring. Pass the lashing from clevis 15A around the padded turret base. Secure both lashings together with two D-rings and a load binder.

Figure 7-13. Turret lashed

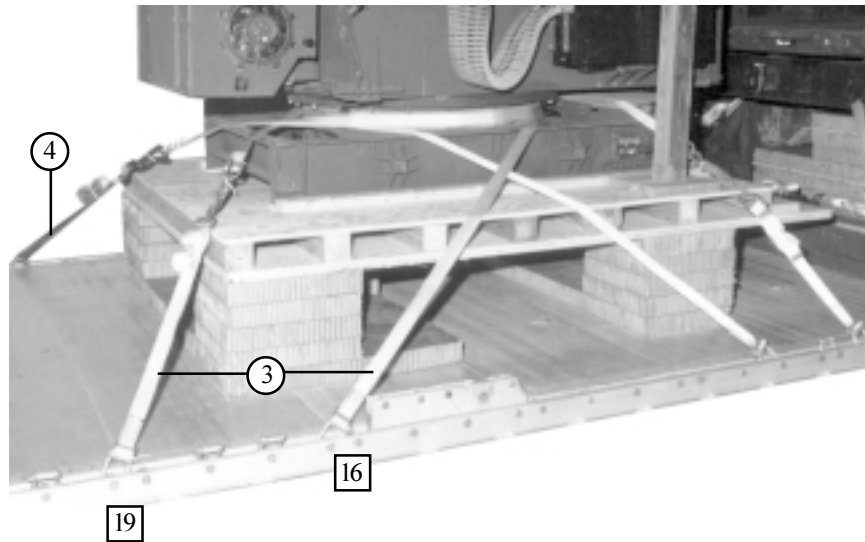

Lashing Number	Tiedown Clevis Number	Instructions
3	19 and 16	Pass a 15-foot lashing through each clevis and through its own D-ring. Pass the lashing from clevis 19 around the padded turret base. Secure both lashings together with two D-rings and a load binder.
4	19A and 16A	Pass a 15-foot lashing through each clevis and through its own D-ring. Pass the lashing from clevis 19A around the padded turret base. Secure both lashings together with two D-rings and a load binder.

Figure 7-13. Turret lashed (continued)

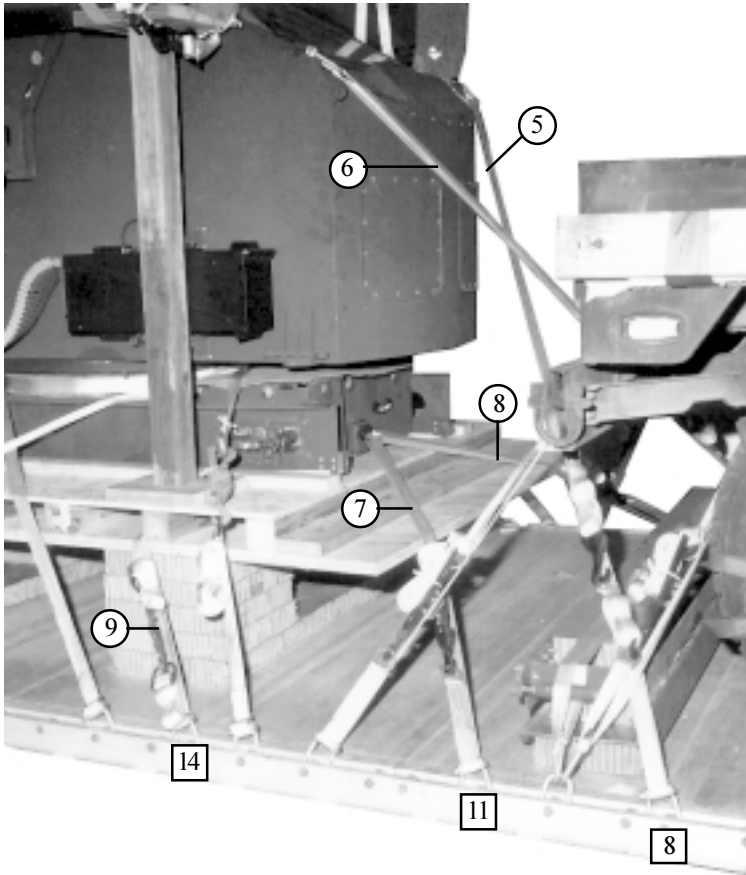

Lashing Number	Tiedown Clevis Number	Instructions
5	8	Pass a 30-foot lashing through the left front lift provision on top of the turret.
6	8A	Pass a 30-foot lashing through the right front lift provision on top of the turret.
7	11	Pass lashing through the winch clevis.
8	11A	Pass lashing through the winch clevis.
9	14 and 14A	Pass a 30-foot lashing through clevis 14, through the second hole in the strongback, through clevis 14A, and back through the second hole in the strongback. Secure both lashings together with two D-rings and a load binder.

Figure 7-13. Turret lashed (continued)

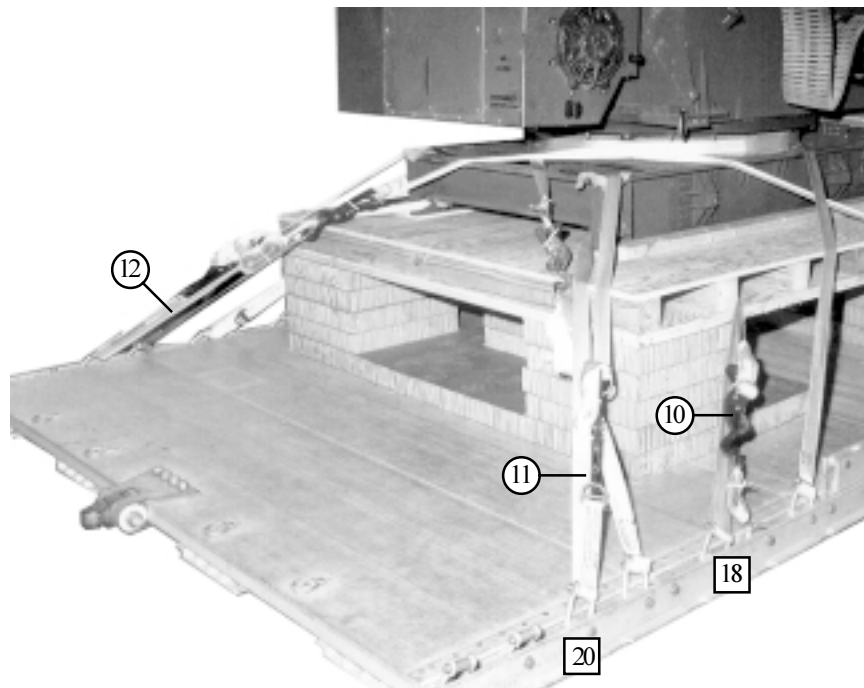

Lashing Number	Tiedown Clevis Number	Instructions
10	18 and 18A	Pass a 30-foot lashing through clevis 18, through the fifth hole in the strongback, through clevis 18A, and back through the fifth hole in the strongback. Secure both lashings together with two D-rings and a load binder.
11	20	Pass lashing around crossbeam on turret base, right side.
12	20A	Pass lashing around crossbeam on turret base, left side.

Figure 7-13. Turret lashed (continued)

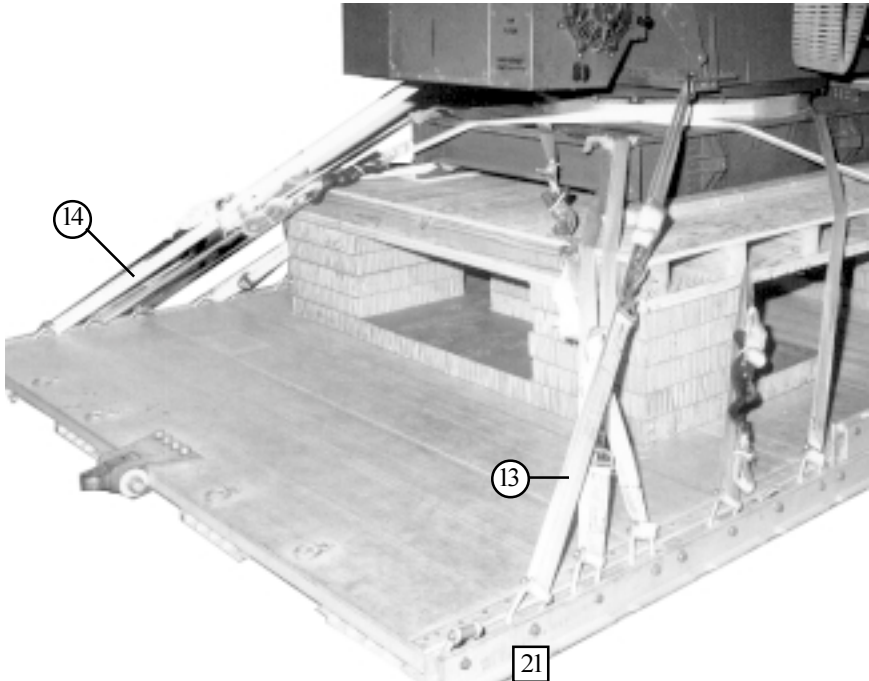

Lashing Number	Tiedown Clevis Number	Instructions
13	21	Attach a platform clevis to the lower right rear mounting hole. Pass a lashing through the tiedown clevis.
14	21A	Attach a platform clevis to the lower left rear mounting hole. Pass a lashing through the tiedown clevis.

Note
When rigging the Avenger without an ECU, install the platform clevises in the rear lifting points located on the top right and left sides of the turret. Lashings 13 and 14 are 30-foot lashings and are routed through the platform clevises previously installed.

Figure 7-13. Turret lashed (continued)

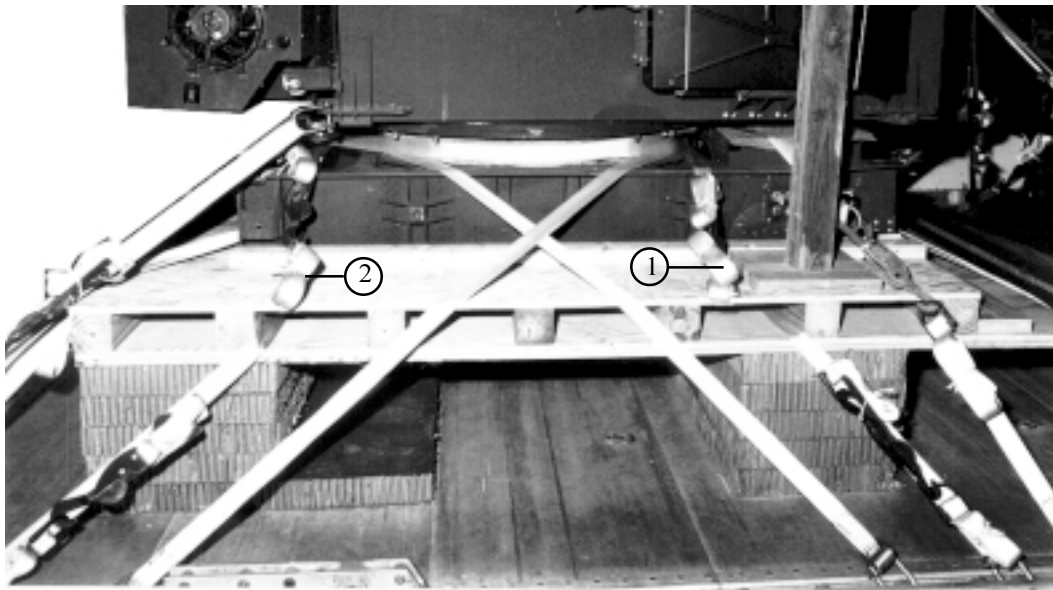

- ① Pass a 30-foot lashing through the second hole in the strongback and back over the turret base. Secure the lashing on the right with two D-rings and a load binder.
- ② Pass a 30-foot lashing through the fifth hole in the strongback and back over the turret base. Secure the lashing on the right with two D-rings and a load binder.

Figure 7-14. Turret lashed to platform

7-11. Installing Supports for Guns, Laser Range Finder, and Environmental Control Unit

Install the honeycomb supports for the gun as shown in

Figure 7-15. Install the support for the environmental control unit as shown in Figure 7-17. Install the honeycomb supports for the laser range finder (LRF) as shown in Figure 7-16. Install the support for the unmodified environmental control unit as shown in Figure 7-18.

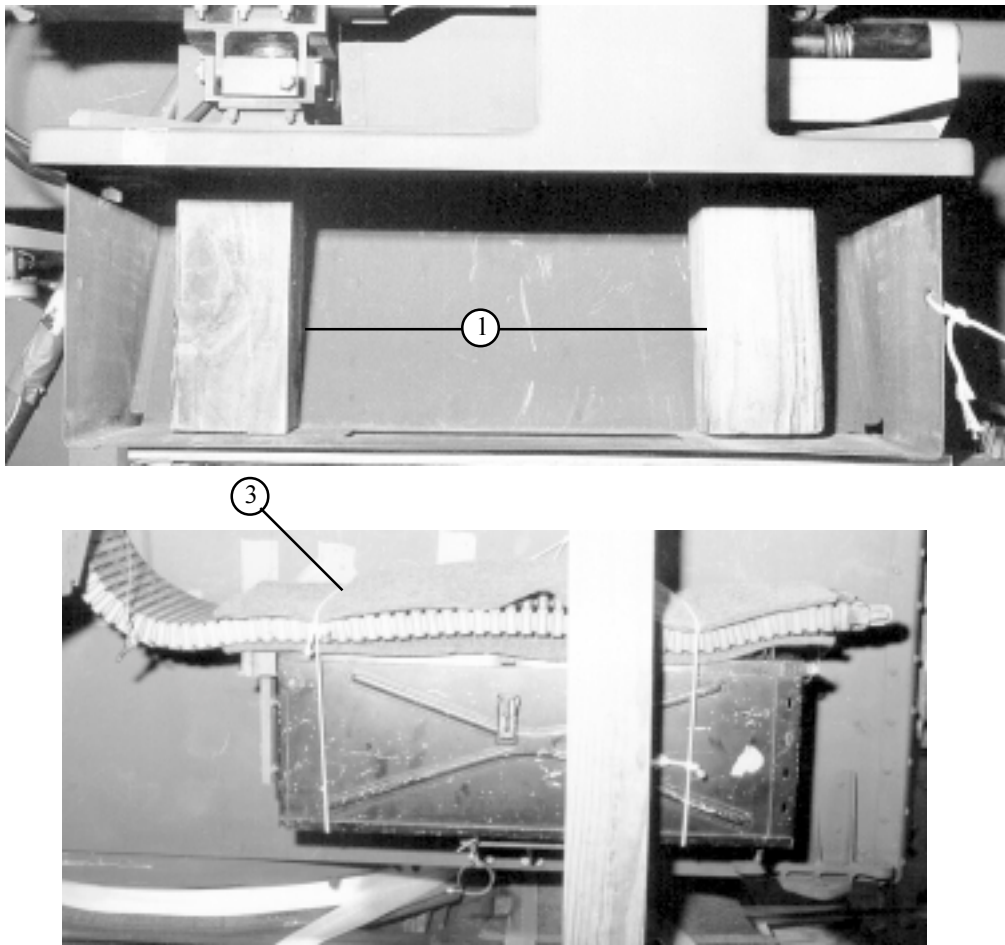

- ① Place two 8 1/4-inch pieces of 4- by 4-inch lumber vertically in the brass collection tray bracket.
- ② Place a 7- by 25-inch piece of honeycomb in the brass collection tray, over the lumber placed in step 1, and secure it in place with type III nylon cord (not shown).
- ③ Disconnect the ammunition feed chute from the gun and the ammunition box. Pad the chute on both sides with 1/2-inch felt, and tie it to the top of the box with type III nylon cord.

Figure 7-15. Gun supported

NOTES: 1. All measurements are given in inches.
2. This drawing is not to scale.

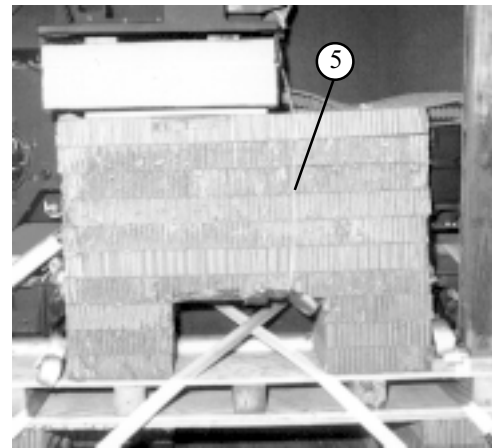
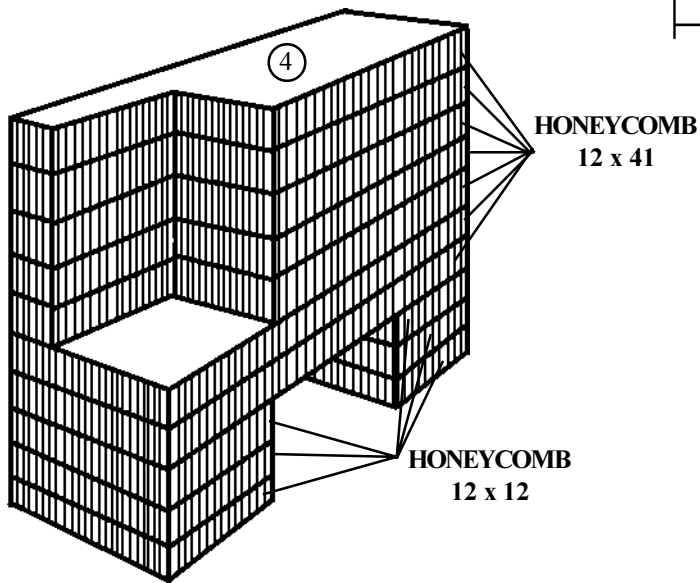
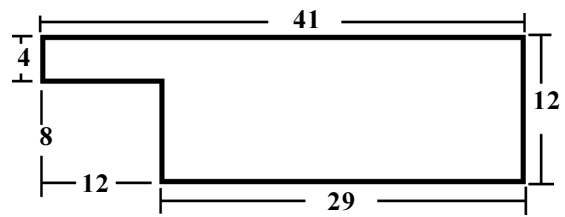

- ④ Build the gun support stack as shown.
- ⑤ Place the honeycomb stack under the gun, with the cutout area flush against the ammunition box. Place a 20- by 10- by 3/4-inch piece of plywood between the support stack and the gun. Tie the stack to convenient points with type III nylon cord. Tape the honeycomb where the type III nylon contacts the edges to prevent cutting.

Figure 7-15. Gun supported (continued)

- NOTES:** 1. All measurements are given in inches.
2. This drawing is not to scale.

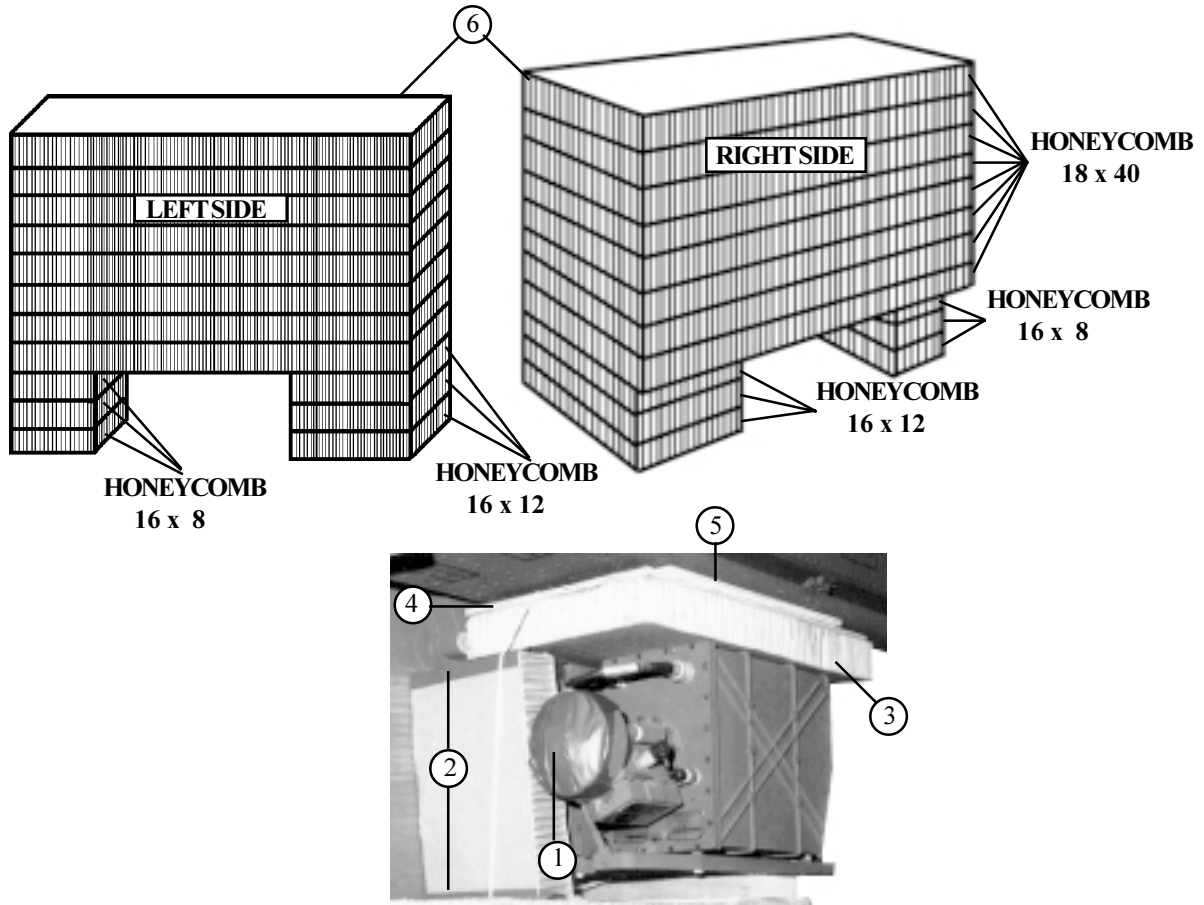

- ① Cover the LRF lens with the lens cap or cellulose padding and tape.
- ② Tape the edges of an 11- by 16-inch piece of honeycomb and place between the turret and the LRF.
- ③ Place a 16- by 26-inch piece of honeycomb on top of the LRF.
- ④ Place a 16- by 26- by 1/2-inch piece of plywood on top of the honeycomb in step 3.
- ⑤ Center and align the outside edges of an 8- by 21- by 1/2-inch piece of plywood over the plywood placed in step 4. Secure the honeycomb and plywood placed above with type III nylon cord.
- ⑥ Build the LRF support stack as shown.

Figure 7-16. LRF supported

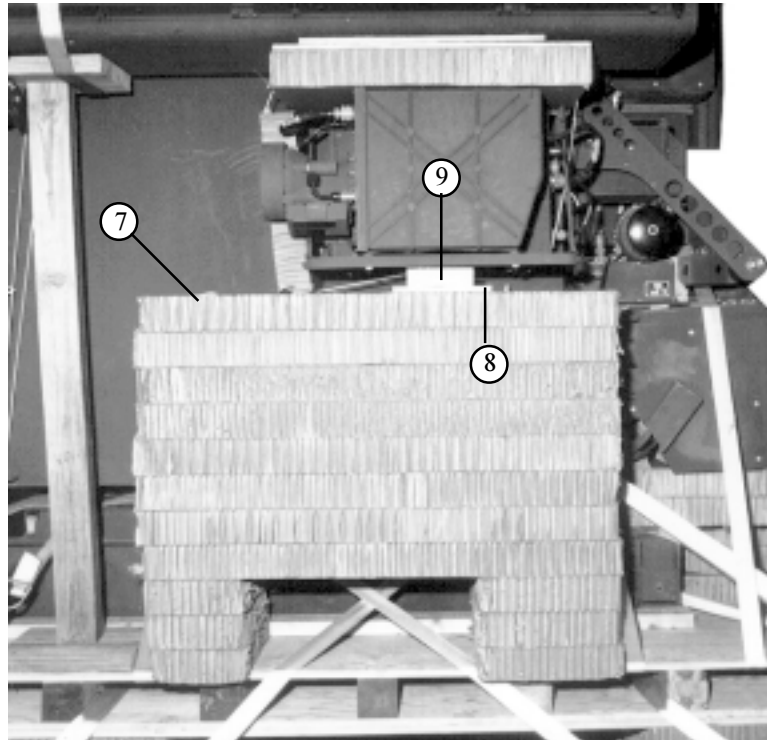

- ⑦ Place the LRF support stack under the LRF with the notched portion toward the turret.
- ⑧ Center an 8- by 19- by 1/2-inch piece of plywood under the LRF. Align the outside edge with the LRF bracket.
- ⑨ Center a 16-inch piece of 2- by 6-inch lumber between the plywood placed in step 8 and LRF bracket. If the plywood and lumber do not fit snugly, shim with 1/4-inch plywood.

Figure 7-16. LRF supported (continued)

- NOTES:**
1. When rigging the Avenger without the modified ECU, omit pages 7-41 and 7-42.
 2. All measurements are given in inches.
 3. This drawing is not to scale.

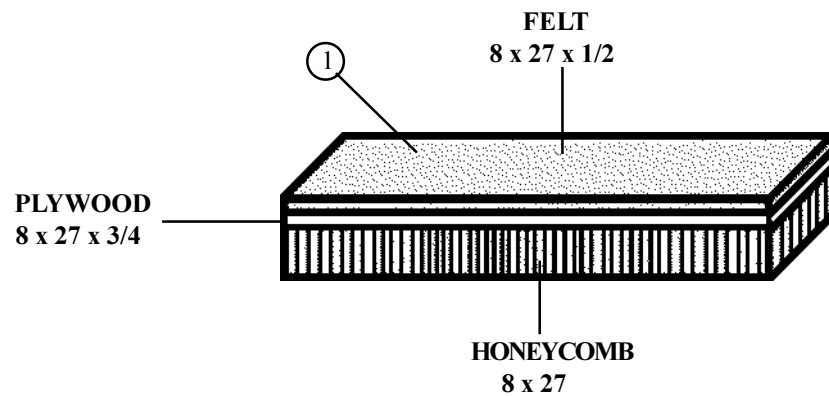

- ① Build the honeycomb, plywood, and felt stack as shown. Glue and nail pieces together as required.
- ② Place the stack assembled in step one between the ECU and the turret base.

Figure 7-17. Modified ECU supported

NOTES: 1. All measurements are given in inches.
2. This drawing is not to scale.

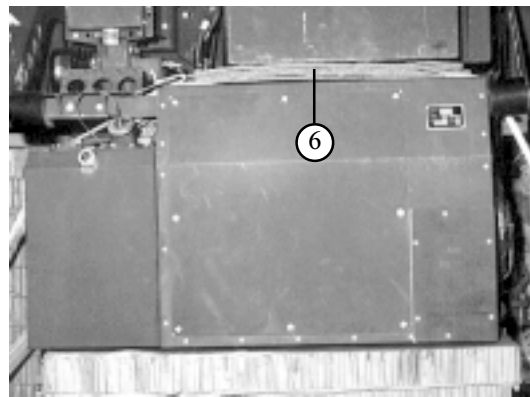
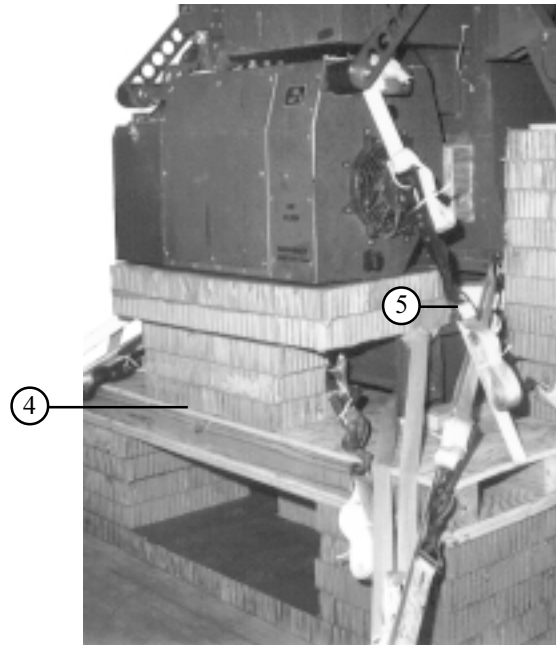
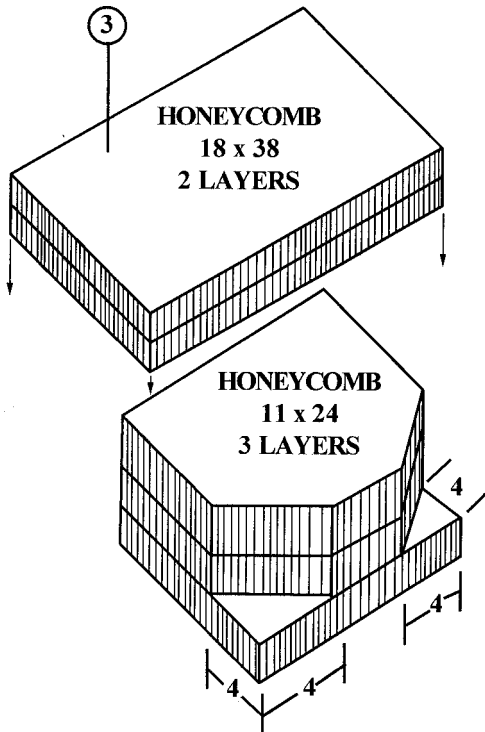

- ③ Build the ECU support stack as shown. Center and glue the top two layers of honeycomb on top of the bottom three layers.
- ④ Place the ECU support stack under the ECU aligning the rear of the stack with the rear of the strongback.
- ⑤ Route a 30-foot lashing through the sixth hole of the strongback and over the ECU.
- ⑥ Place pieces of 1/2-inch felt to fill the area between the primary power unit (PPU) and ECU.

Figure 7-17. Modified ECU supported

- NOTES:**
1. When rigging the Avenger without the modified ECU, use these procedures.
 2. All measurements are given in inches.
 3. This drawing is not to scale.

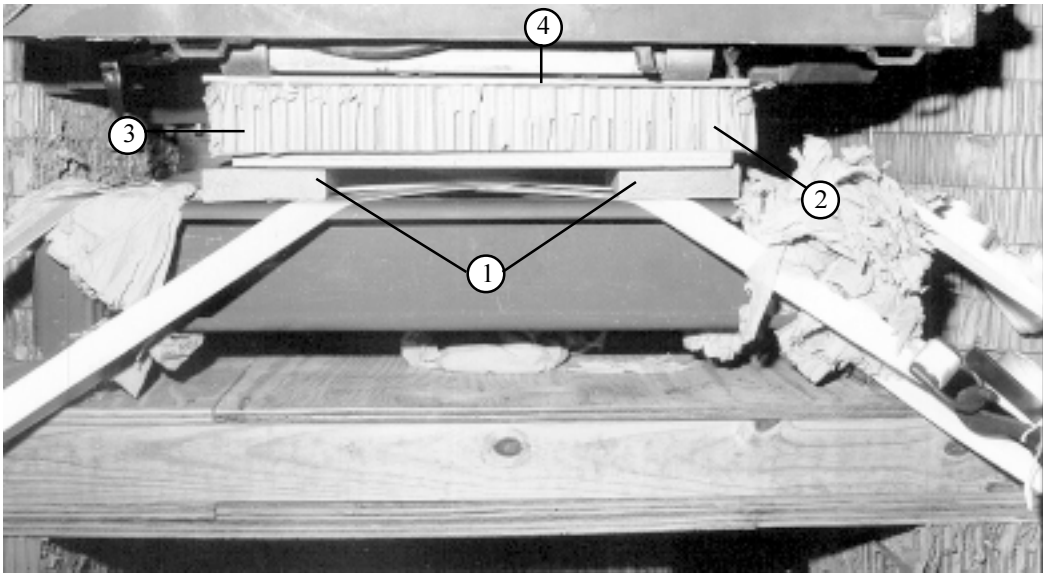
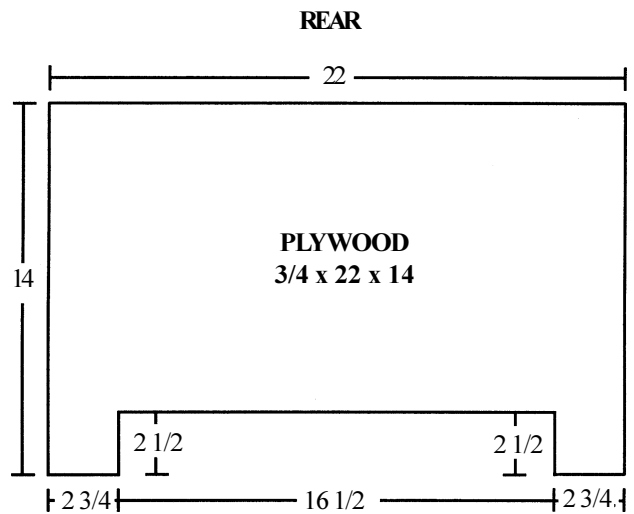

- ① Place two 12-inch pieces of 2- by 6-inch lumber 13 inches apart on the turret base under the ECU.
- ② Center a piece of 3/4-inch plywood cut as shown over the lumber, with the cutout facing the front.
- ③ Center a 10- by 24-inch piece of honeycomb over the plywood.
- ④ Fit a 10- by 24-inch piece of 1/4-inch plywood in the remaining space. Be sure the fit of these pieces is snug. If not, wedge another piece of 1/4-inch plywood in the space.

Figure 7-18. Unmodified ECU supported

7-12. Covering Turret Canopy

Install the canopy protection board and the load cover as shown in Figure 7-19.

- NOTES:** 1. All measurements are given in inches.
 2. This drawing is not to scale.
 3. All holes are 1/2 inch.

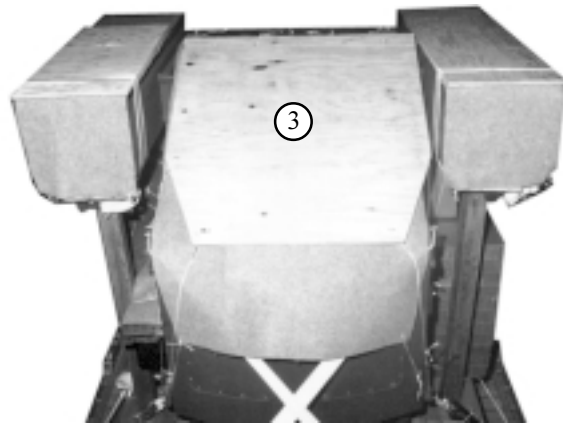
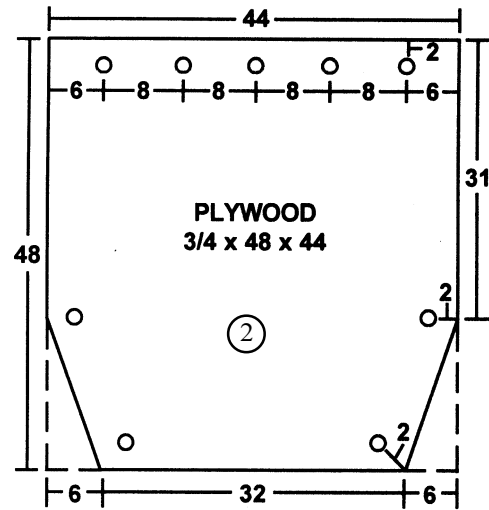
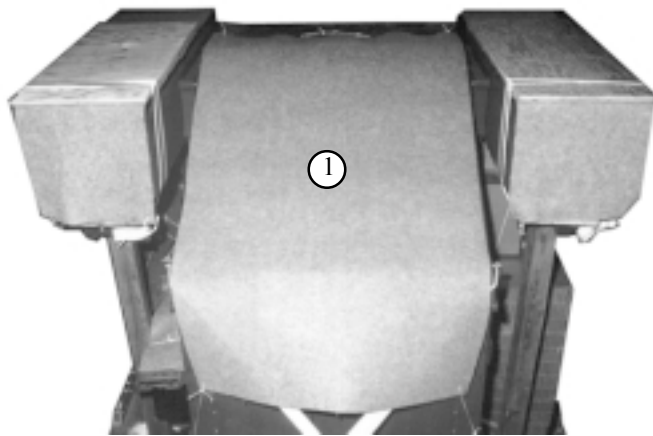

- ① Place a 1/2- by 43- by 72-inch piece of 1/2-inch felt over the canopy with the front edge of the 1/2-inch felt over hanging the front edge of the turret 16 inches. Punch holes in the corners of the 1/2-inch felt and secure it to convenient points with type III nylon cord.
- ② Make the canopy protection board with 3/4-inch plywood as shown.
- ③ Place the protection board over the 1/2-inch felt as shown. Ensure the front edge covers the IFF antenna. Secure the protection board to convenient points with type III nylon cord.

Figure 7-19. Canopy protected

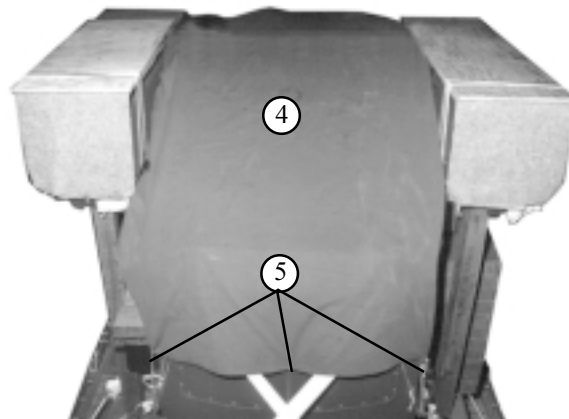

FRONT

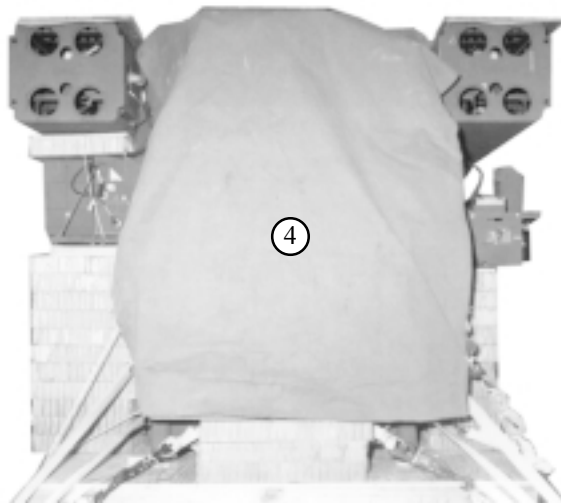

REAR

- ④ Place a load cover 58 inches wide and 165 inches long over the turret. Extend the rear edge of the cover to the bottom of the ECU base.
- ⑤ Tie the cover to convenient points on the load with type III nylon cord.

Figure 7-19. Canopy protected (continued)

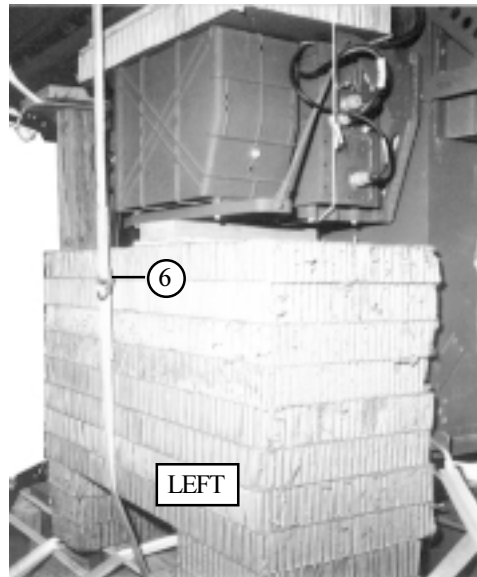
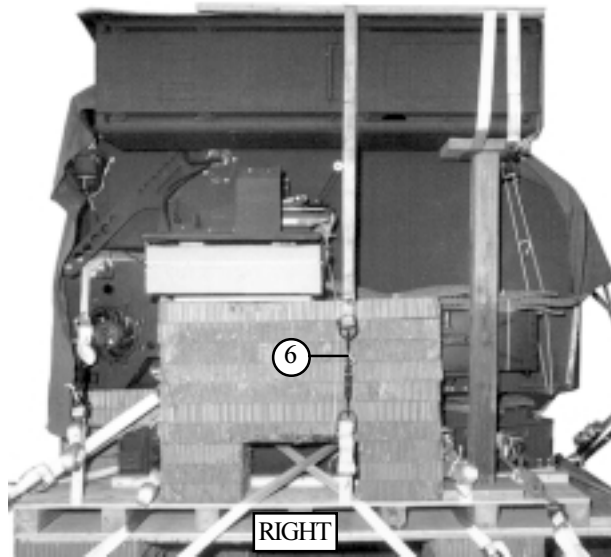

- ⑥ Pass a 30-foot lashing through the third hole in the strongback and over the top of the turret. Ensure the D-rings and load binder are positioned on the honeycomb support stack and not against metal.

Figure 7-19. Canopy protected (continued)

7-13. Suspension Slings Installed and Safetied

Install and safety the suspension slings according to FM 10-500-2/TO 13C7-1-5 and as shown in Figure 7-20.

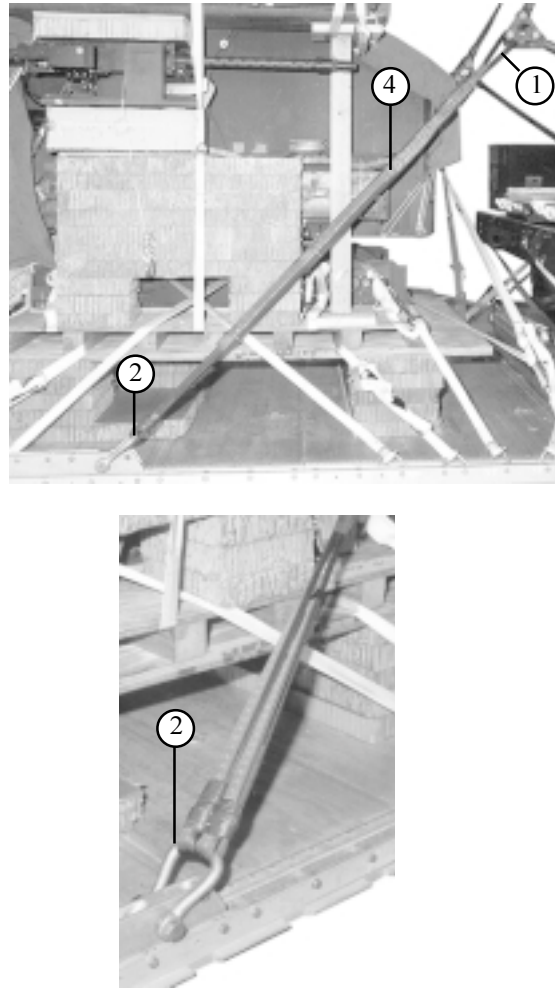

- ① Pass a 16-foot (2-loop), type XXVI nylon webbing sling around one point of a 3-point link.
- ② Place both ends of the sling on the bell portion of a large suspension clevis. Bolt the clevis on the right rear suspension link.
- ③ Repeat steps 1 and 2 on the left side.
- ④ Pad the rear suspension slings from 30 inches above the clevises to 90 inches above the clevises with 1/2-inch felt. Tape the 1/2-inch felt in place.

Figure 7-20. Suspension slings installed and safetied

- NOTES:** 1. All measurements are given in inches.
2. This drawing is not to scale.

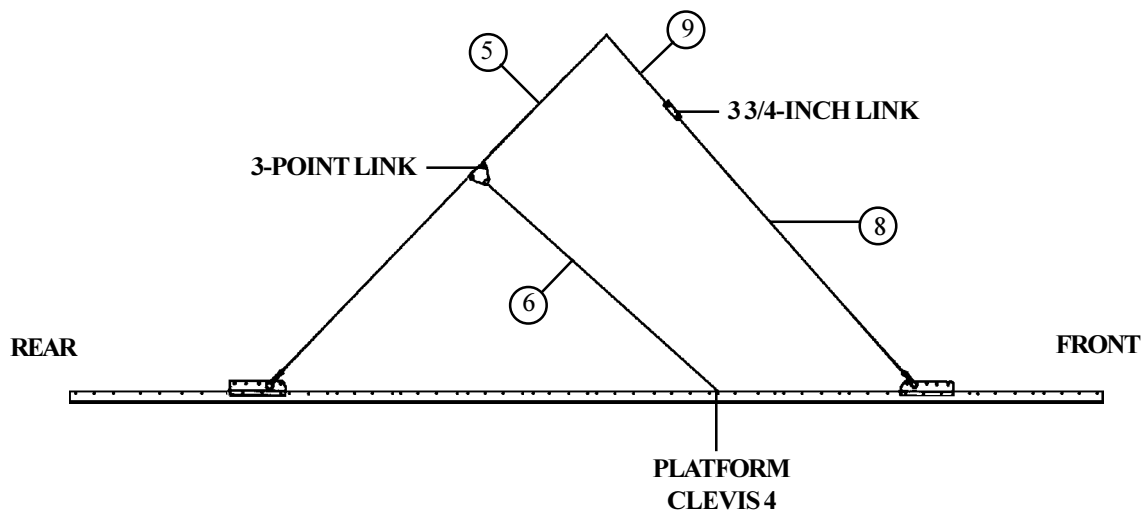

- ⑤ Attach a 9-foot (2-loop), type XXVI nylon webbing sling to the top point of each 3-point link.
- ⑥ Attach an 11-foot (2-loop), type XXVI nylon webbing sling to the third point (inside point) of the 3-point link. Attach the other end of the sling to platform clevis 4.
- ⑦ Repeat the procedures in step 6 on the left side and attach the sling to platform clevis 4A.
- ⑧ Attach a 12-foot (2-loop), type XXVI nylon webbing sling to each front suspension link with a large suspension clevis. Attach the other end of the 12-foot slings to a 3 3/4-inch link.
- ⑨ Attach a 3-foot (2-loop), type XXVI nylon webbing sling to the other end of the 3 3/4-inch link installed in step 8. Pad the 3 3/4-inch links with 1/2-inch felt and secure the 1/2-inch felt with tape.

Figure 7-20. Suspension slings installed and safetied (continued)

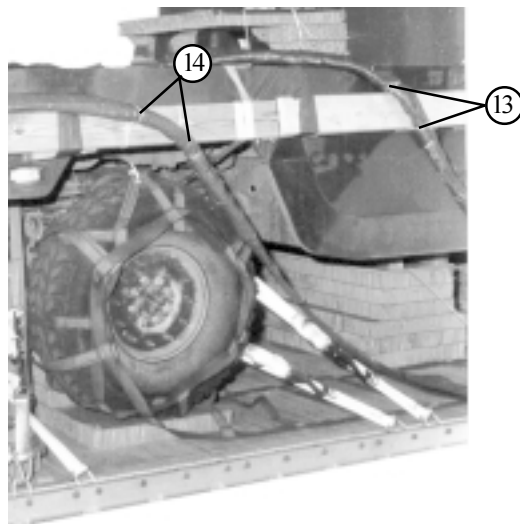
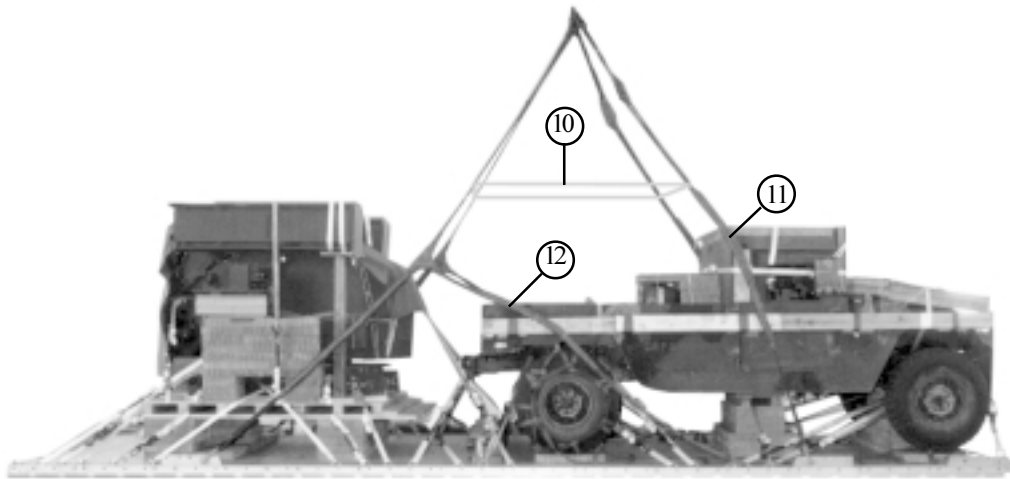

- ⑩ Raise the suspension slings and install the deadman's tie to the front and rear slings according to FM 10-500-2/TO 13C7-1-5.
- ⑪ Pad the front suspension slings from a point 32 inches above the suspension clevises to a point 96 inches above the clevises with 1/2-inch felt. Tape the 1/2-inch felt in place.
- ⑫ Pad the center suspension slings from a point 60 inches above the platform clevises to a point 108 inches above the platform clevises with 1/2-inch felt. Tape the 1/2-inch felt in place.
- ⑬ Tie the front suspension slings to the sideboards on the truck with type III nylon cord.
- ⑭ Tie the center suspension slings to the sideboards on the truck with type III nylon cord.

Figure 7-20. Suspension slings installed and safetied (continued)

NOTE: The 1/2-inch tubular nylon webbing ties in steps 16, 17, and 18 must be routed under all the suspension slings. These ties serve as guides for the suspension slings.

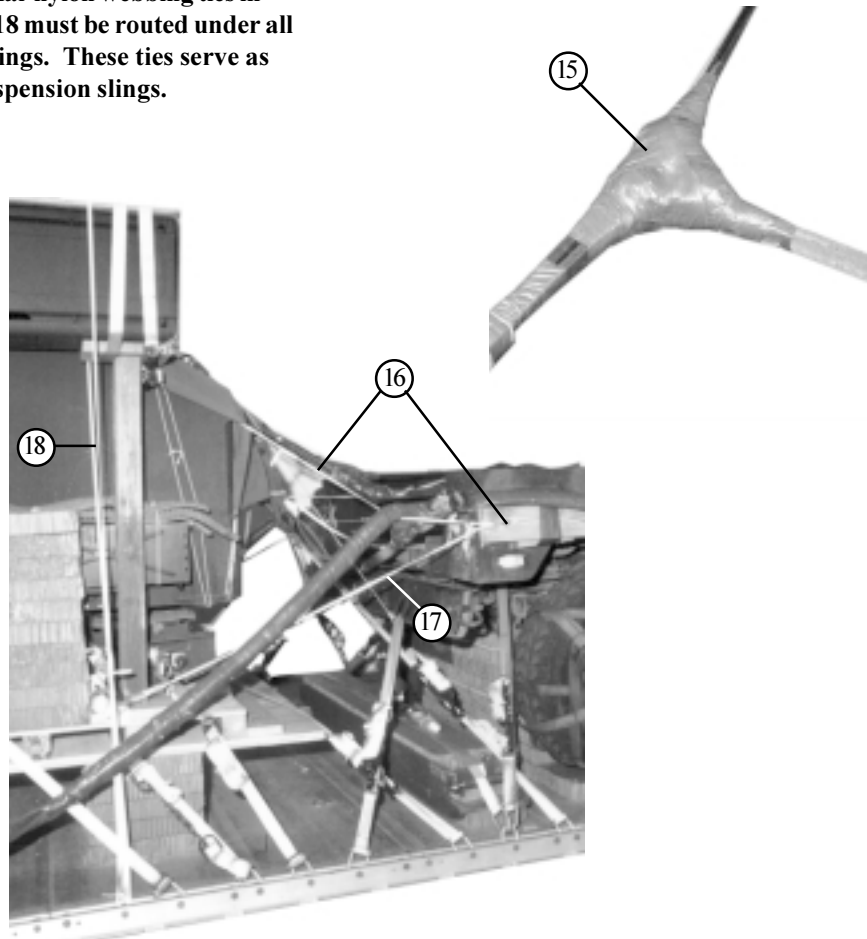

- (15) Pad the 3-point link with cellulose wadding and tape.
- (16) Route a length of 1/2-inch tubular nylon webbing from the 1/2-inch hole in the end of the right sideboard to the right, top, front lift provision. Repeat the procedure on the left side using the 1/2-inch hole in the left rear sideboard and the left, top, front lift provision.
- (17) Route a length of 1/2-inch tubular nylon webbing from the 1/2-inch hole in the end of the right sideboard to the D-ring of the lashing going through the second hole in the strongback. Repeat the procedure on the left side using the 1/2-inch hole in the left rear sideboard and the D-ring of the lashing going through the second hole in the strongback.
- (18) Route a length of 1/2-inch tubular nylon webbing from bushing 39, around the right weapon pod, and secure the webbing to bushing 39. Repeat the procedure on the left side using bushing 39A.

Figure 7-20. Suspension slings installed and safetied (continued)

7-14. Stowing Cargo Parachutes

Stow three G-11 cargo parachutes on this load. Build and

install the parachute stowage platform as shown in Figure 7-21. Install the parachutes according to FM 10-500-2/TO 13C7-1-5 and as shown in Figure 7-22.

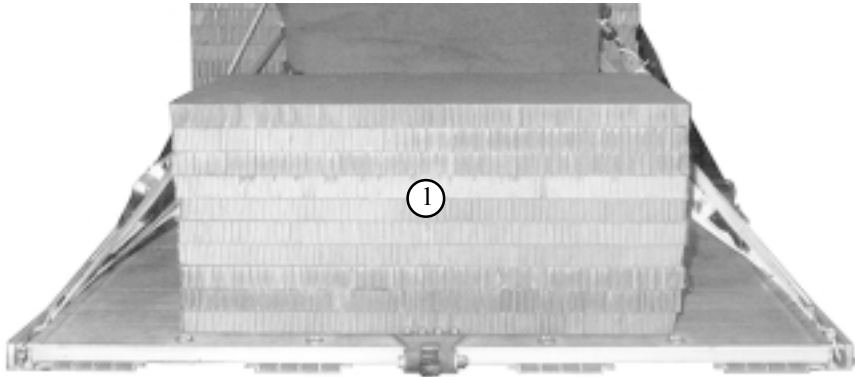

- NOTES: 1. All measurements are given in inches.
 2. This drawing is not to scale.

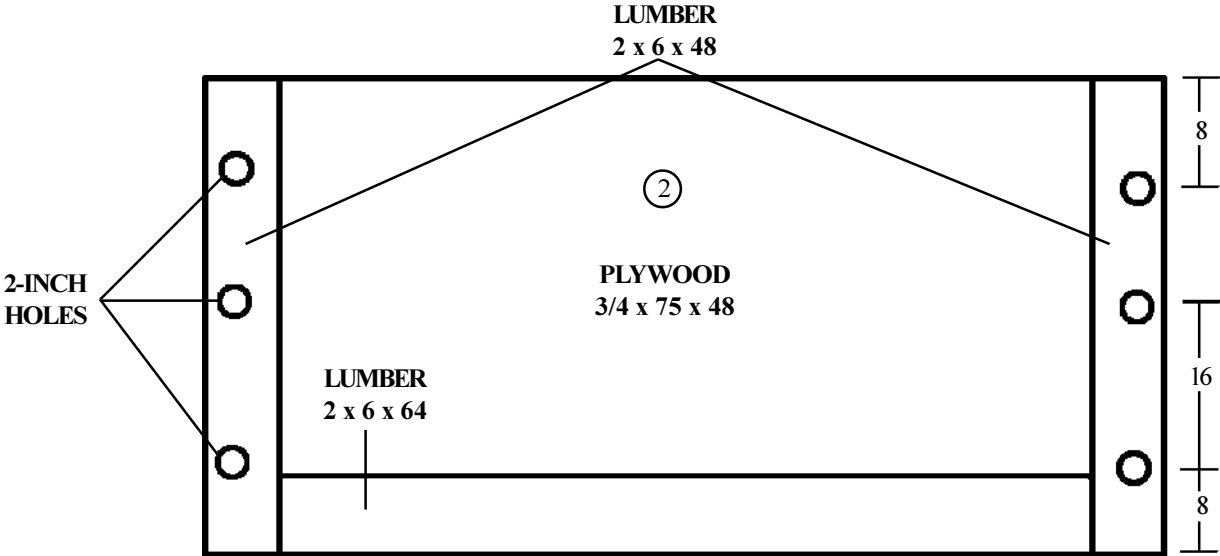

- ① Center ten pieces of 36- by 64-inch honeycomb against the rear of the strongback. Notch layers 6 and 7 to allow for the lashings. Glue the layers together.
- ② Build the parachute stowage platform with 3/4-inch plywood and 2- by 6-inch lumber as shown. Nail the plywood to the 2- by 6-inch lumber.

Figure 7-21. Parachute stowage platform built and installed

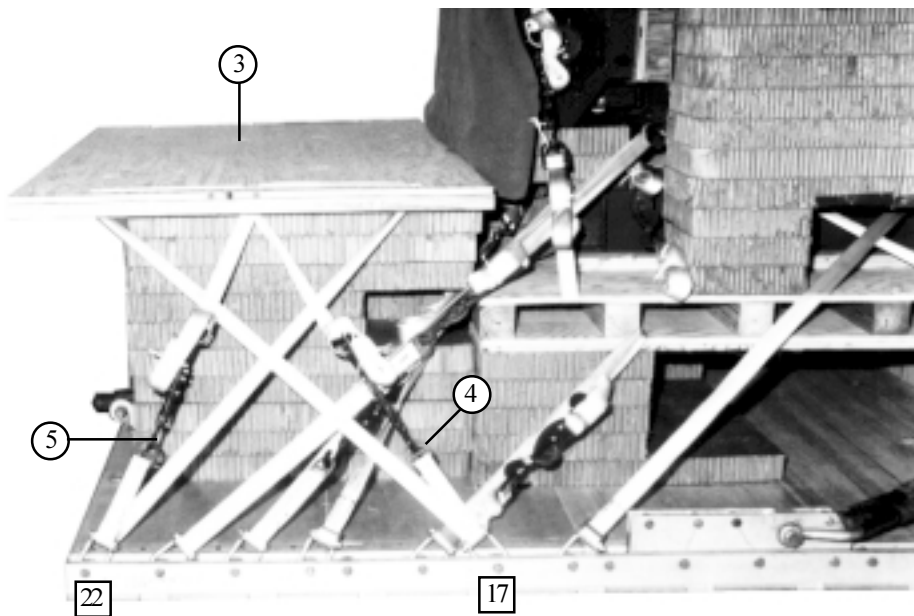

- ③ Place the parachute stowage platform on the honeycomb so it overhangs the rear of the honeycomb by 10 inches.
- ④ Lash the parachute stowage platform to clevises 17 and 17A through the center and rear holes on each side.
- ⑤ Lash the parachute stowage platform to clevises 22 and 22A through the center and front holes on each side.

Figure 7-21. Parachute stowage platform built and installed (continued)

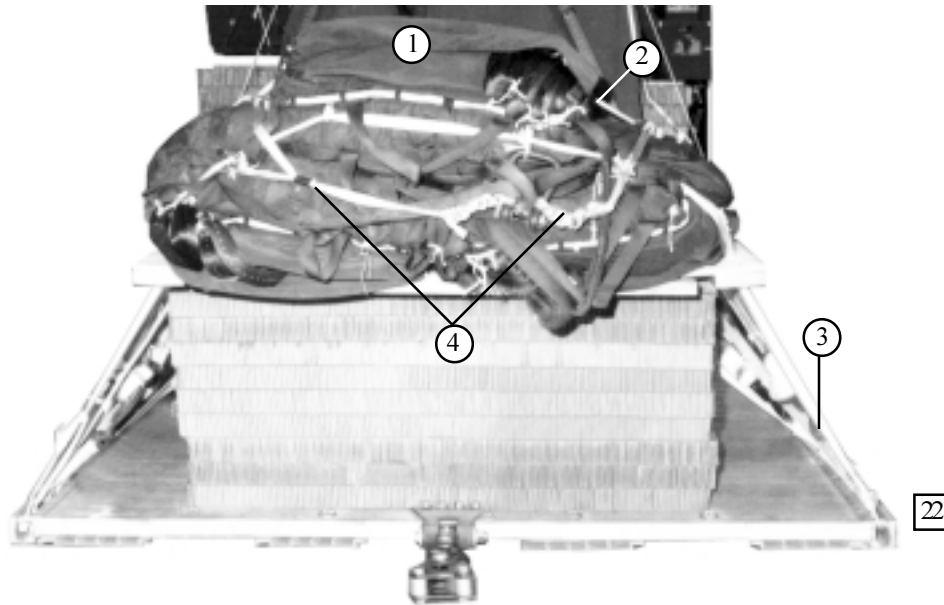

- ① Prepare, install, and restrain three G-11 cargo parachutes according to FM 10-500-2/TO 13C7-1-5.
- ② Tie the front parachute restraint strap to bushings 52 and 52A.
- ③ Tie the rear parachute restraint strap clevises to 22 and 22A.
- ④ Install the parachute release strap according to FM 10-500-2/TO 13C7-1-5.

Figure 7-22. Cargo parachutes installed

7-15. Installing Extraction System

Install the Extraction Force Transfer Coupling (EFTC) extraction system according to FM 10-500-2/TO 13C7-1-5 and as shown in Figure 7-23.

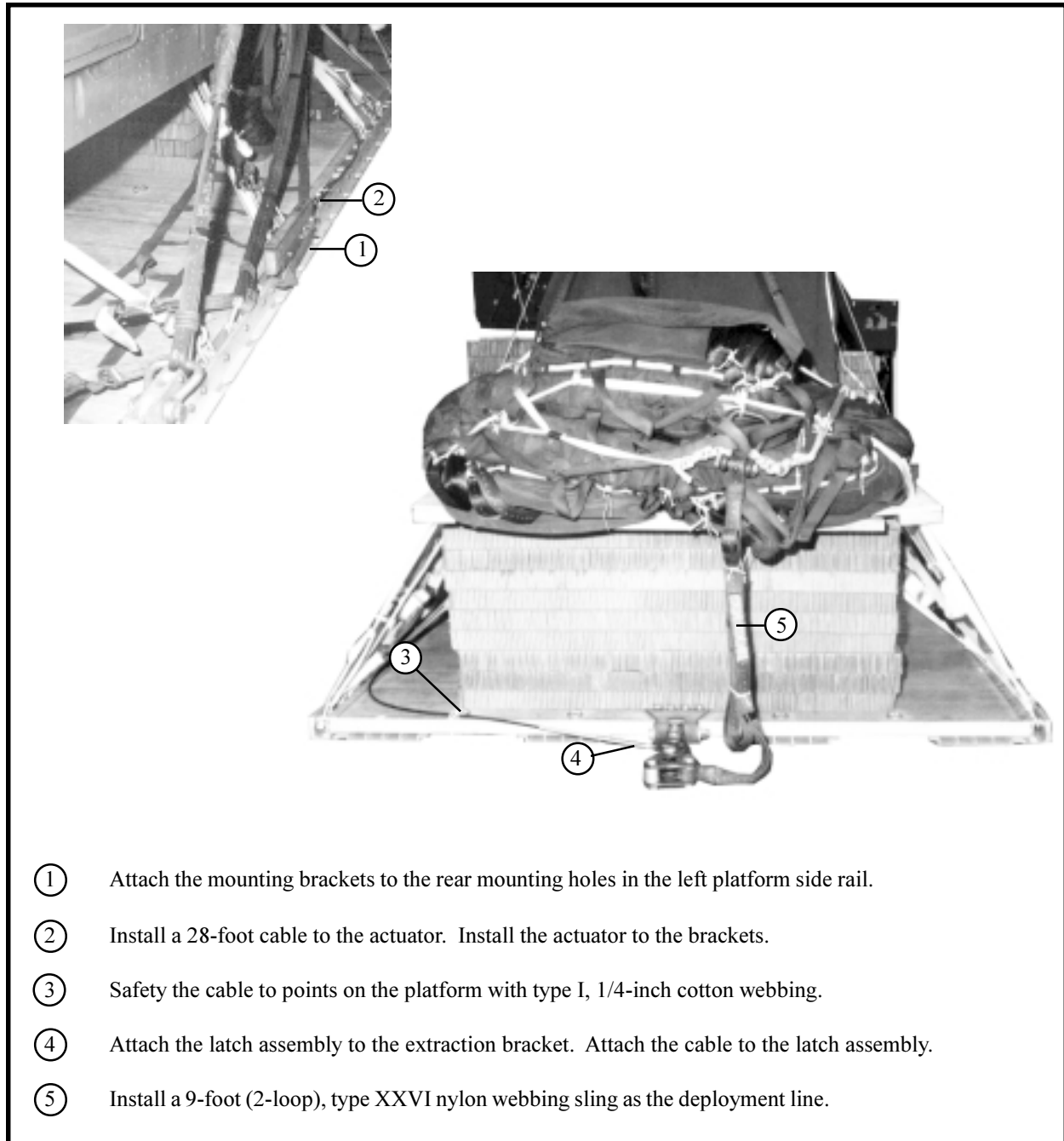
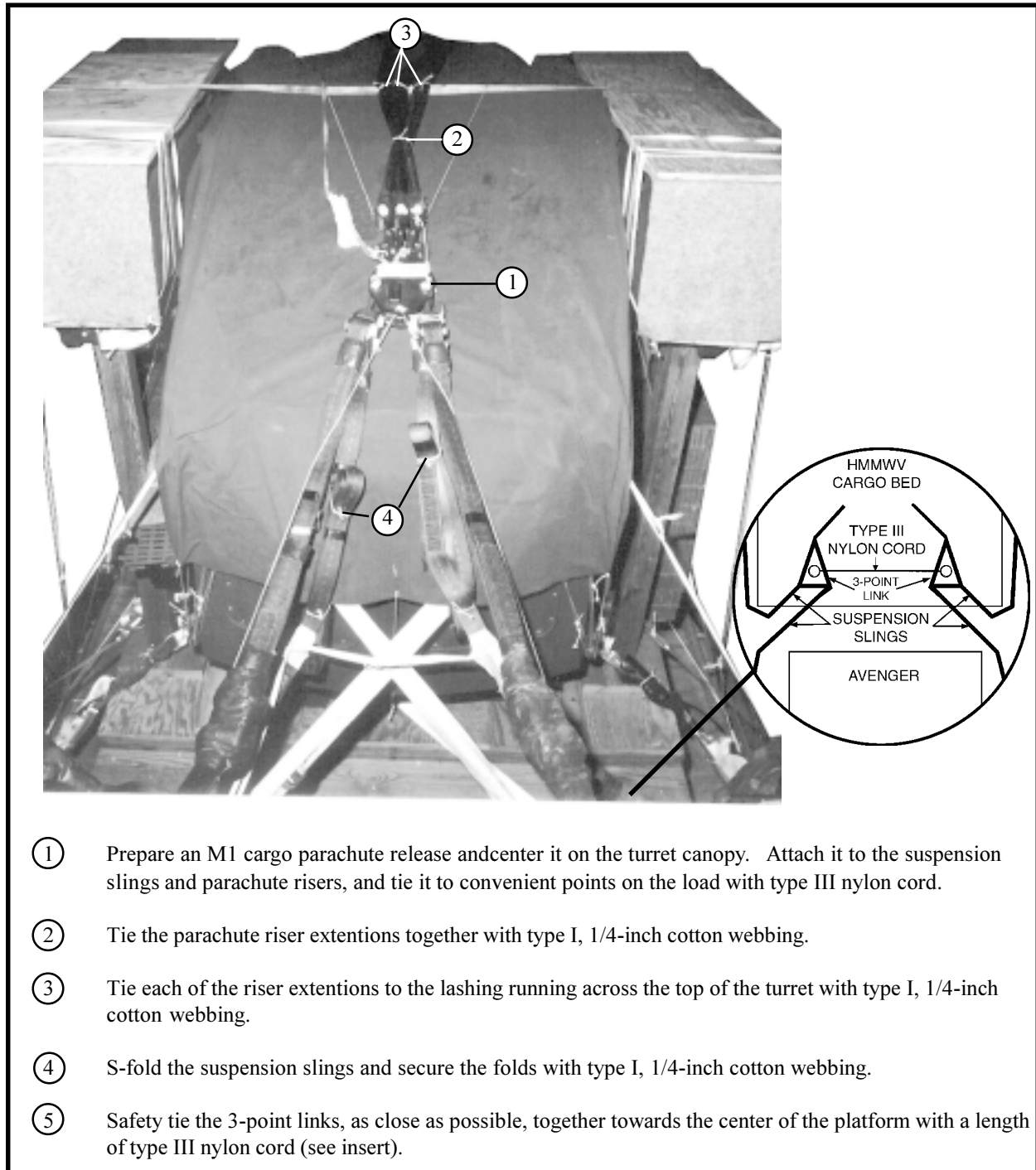

Figure 7-23. EFTC installed

7-16. Installing Release System

ing to FM 10-500-2/TO 13C7-1-5 and as shown in Figure 7-24.

Prepare and install an M1 cargo parachute release accord-



- ① Prepare an M1 cargo parachute release and center it on the turret canopy. Attach it to the suspension slings and parachute risers, and tie it to convenient points on the load with type III nylon cord.
- ② Tie the parachute riser extensions together with type I, 1/4-inch cotton webbing.
- ③ Tie each of the riser extensions to the lashing running across the top of the turret with type I, 1/4-inch cotton webbing.
- ④ S-fold the suspension slings and secure the folds with type I, 1/4-inch cotton webbing.
- ⑤ Safety tie the 3-point links, as close as possible, together towards the center of the platform with a length of type III nylon cord (see insert).

Figure 7-24. Release system installed

7-17. Placing Extraction Parachute

Select the extraction parachute and extraction line needed using the extraction line requirements table in FM 10-500-2/TO 13C7-1-5. Place the extraction parachute and extraction line on the load for installation in the aircraft.

7-18. Installing Provisions for Emergency Restraint

Select and install the provisions for the emergency aft restraints according to the emergency aft restraint requirements table in FM 10-500-2/TO 13C7-1-5.

7-19. Marking Rigged Load

Mark the rigged load according to FM 10-500-2/TO 13C7-1-5 and as shown in Figure 10-17. Complete Shipper's Declaration for Dangerous Goods and affix to the load. If the load varies from the one shown, the weight, height, center of balance (CB), tipoff curve, and parachute requirements must be recomputed.

7-20. Equipment Required

Use the equipment listed in Table 7-1 to rig the load shown in Figure 7-25.

CAUTION
Make the final rigger inspection required by FM 10-500-2/TO 13C7-1-5 before the load leaves the rigging site.

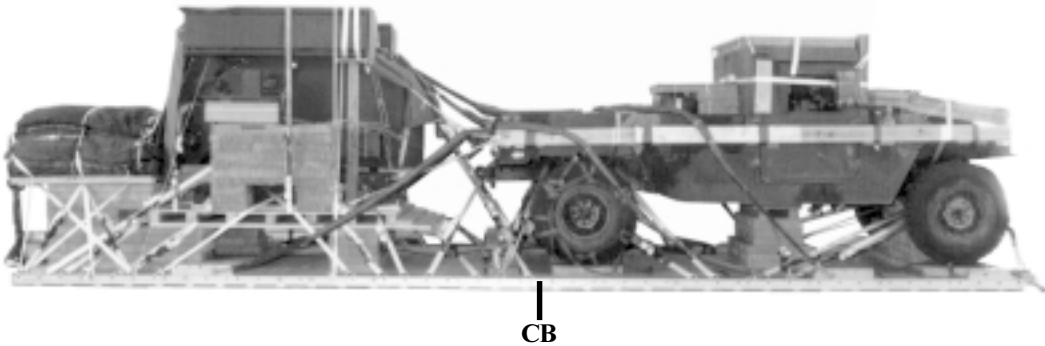

RIGGED LOAD DATA

Weight.....	14,182 pounds
Maximum Weight.....	15,750 pounds
Height.....	95 inches
Width.....	108 inches
Overall Length	354 inches
Overhang: Front.....	0 inches
Rear (EFTC).....	18 inches
Center of Balance (CB) (from front edge of the platform)	176 inches
Extraction System.....	EFTC

Figure 7-25. Avenger air defense weapon system with ECU and M1097A2 truck, rigged on a 28-foot type V platform for low-velocity airdrop

Table 7-1. Equipment required for rigging the Avenger air defense weapon system with ECU on M1097A2 truck on a 28-foot type V platform for low-velocity airdrop

National Stock Number	Item	Quantity
1670-00-162-4981	Adapter, coupling, EFTC	2
8040-00-273-8713	Adhesive paste, 1-gal.	As required
1670-01-035-6054	Bridle, extraction line, leaf (C-17 only)	1
	Clevis, suspension:	
4030-00-678-8562	3/4-inch (medium)	4
4030-00-090-5354	1-inch (large)	5
8305-00-242-3593	Cloth, cotton duck, 60-inches	As required
4020-00-240-2146	Cord, nylon, type III, 550-lb.	As required
1670-01-423-4102	Coupling, airdrop extraction force transfer, w/28-ft. cable	1
1670-00-360-0328	Cover, clevis	9
1670-00-360-0329	Cover, link assembly (type IV)	3
8135-00-664-6958	Cushioning material, packaging, cellulose wadding	As required
1670-01-344-0825	Drive off aid, Airdrop	1
8305-00-958-3685	Felt, 1/2-inch thick	As required
1670-01-183-2678	Leaf, extraction line (line bag) (add 2 for C-17)	2
	Line extraction:	
1670-01-062-6313	60-foot (3-loop), type XXVI (for C-130)	1
1670-01-107-7651	140-foot (3-loop), type XXVI (for C-141)	1
1670-01-107-7651	140-foot (3-loop), type XXVI, (for C-5 between fuselage stations 1427-1971)	1
1670-01-107-7651	140-foot (3-loop), type XXVI and	1
1670-01-062-6313	60-foot (3-loop), type XXVI, (for C-5 between fuselage stations 707-1426)	1
1670-01-107-7651	140-foot (3-loop), type XXVI (for C-17)	1
1670-01-064-4452	60-foot (1-loop), type XXVI (for C-17), (drogue line)	1
1670-00-783-5988	Link assembly, type IV (add 1 for C-17)	3
	Link assembly, two-point:	
5306-00-435-8994	Bolt, 1-inch diameter, 4-inches long (add 2 for C-5)	4
5310-00-232-5165	Nut, 1-inch (add 2 for C-5)	4
1670-00-003-1954	Plate, side, 3 3/4-inch (add 2 for C-5)	4
5365-00-007-3414	Spacer, large (add 2 for C-5)	4
1670-01-307-0155	Link, assembly, coupling, three-point	2
	Lumber:	
5510-00-220-6146	2- by 4- by 73-inch	2
5510-00-220-6148	2- by 6- by 13-inch	2
	2- by 6- by 16-inch	2
	2- by 6- by 48-inch	2
	2- by 6- by 56-inch	2
	2- by 6- by 64-inch	1
	2- by 6- by 72-inch	1
	2- by 6- by 176-inch	2
5510-00-220-6246	2- by 8- by 18-inch	2
5510-00-220-6250	2- by 12- by 12-inch	4

Table 7-1. Equipment required for rigging the Avenger air defense weapon system with ECU on M1097A2 truck on a 28-foot type V platform for low-velocity airdrop (continued)

National Stock Number	Item	Quantity
5510-00-220-6274	Lumber: 4- by 4- by 8 1/2-inch 4- by 4- by 43-inch 4- by 4- by 50-inch 4- by 4- by 72-inch	2 2 2 7
5315-00-010-4659	Nail, steel, common, 8D	As required
5315-00-753-3885	Nail, steel, common, 16D	As required
1670-00-753-3928	Pad, energy-dissipating (honeycomb) 3- by 36- by 96-inches 5 1/2- by 10-inch 7- by 25-inch 8- by 16-inch 8- by 27-inch 10- by 10-inch 10- by 24-inch 10- by 80-inch 11- by 16-inch 11- by 24-inch 12- by 12-inch 12- by 16-inch 12- by 18-inch 12- by 24-inch 12- by 28-inch 12- by 41-inch 12- by 82-inch 13- by 40-inch 14- by 32-inch 16- by 16-inch 16- by 26-inch 16- by 32-inch 16- by 72-inch 18- by 18-inch 18- by 38-inch 18- by 40-inch 18- by 43-inch 20- by 24-inch 23- by 83-inch 24- by 54-inch 24- by 80-inch 26- by 43-inch 28- by 32-inch 36- by 64-inch	30 sheets (10) (1) (3) (1) (5) (1) (1) (1) (1) (3) (6) (3) (10) (1) (1) (7) (2) (1) (3) (12) (1) (1) (1) (8) (2) (8) (4) (6) (1) (8) (2) (3) (1) (10)

Table 7-1. Equipment required for rigging the Avenger air defense weapon system with ECU on M1097A2 truck on a 28-foot type V platform for low-velocity airdrop (continued)

National Stock Number	Item	Quantity
1670-00-753-3928	Pad, energy-dissipating (honeycomb)	
	36- by 72-inch	(1)
	36- by 80-inch	(1)
	36- by 82-inch	(2)
1670-01-016-7841	Parachute, cargo, G-11	3
	Parachute, cargo, extraction:	
	22-ft.	1
1670-01-063-3716	15-ft. (C-17 only)	1
1670-01-063-3715	Platform, airdrop, type V, 28-ft:	
	Clevis assembly (type V)	(54)
1670-01-162-2372	Extraction bracket assembly	(1)
1670-01-162-2376	Link, suspension bracket, type V	(4)
1670-01-247-2389	Tandem link assembly (Multipurpose link)	(2)
1670-01-162-2381	Plywood:	
	1/4-inch:	
	9 1/2- by 24-inch	1
5530-00-129-7721	1/2-inch	
	8- by 19-inch	1
	8- by 21-inch	1
	16- by 26-inch	1
5530-00-129-7777	3/4-inch:	8 sheets
	8- by 8-inch	(2)
	8- by 27-inch	(1)
	10- by 20-inch	(1)
	12- by 24-inch	(1)
	14- by 22-inch	(1)
	18- by 43-inch	(2)
	18- by 48-inch	(2)
	20- by 24-inch	(2)
	24- by 54-inch	(2)
	24- by 84-inch	(1)
	24- by 96-inch	(2)
	39- by 80-inch	(1)
	44- by 48-inch	(1)
	48- by 75-inch	(1)
	48- by 84-inch	(1)
	48- by 96-inch	(2)
1670-01-097-8816	Release, cargo parachute, M-1	1

Table 7-1. Equipment required for rigging the Avenger air defense weapon system with ECU on M1097A2 truck on a 28-foot type V platform for low-velocity airdrop (continued)

National Stock Number	Item	Quantity
	Sling, cargo, airdrop:	
	For deployment line:	
1670-01-062-6304	9-ft. (2-loop), type XXVI	1
	For riser extentions:	
1670-01-062-6302	20-ft. (2-loop), type XXVI	6
	For lifting:	
1670-01-062-6304	9-ft. (2-loop), type XXVI	2
1670-01-062-6303	12-ft. (2-loop), type XXVI	2
1670-01-063-7760	11-ft. (2-loop), type XXVI	2
	For suspension slings:	
1670-01-062-6301	3-ft. (2-loop), type XXVI	2
1670-01-062-6304	9-ft. (2-loop), type XXVI	2
1670-01-063-7760	11-ft. (2-loop), type XXVI	2
1670-01-062-6303	12-ft. (2-loop), type XXVI	2
1670-01-063-7761	16-ft. (2-loop), type XXVI	2
5340-00-040-8219	Strap, parachute, release, multi-knife	2
7501-00-266-5016	Tape, adhesive, 2-inch	As required
1670-00-937-0271	Tiedown assembly, 15-ft.	63
TBD	Towplate release mechanism (H-block) (C-17 only)	1
	Webbing:	
8305-00-268-2411	Cotton, 1/4-inch, type I	As required
8305-00-082-5752	Nylon, tubular, 1/2-inch	As required
8305-00-263-3598	Nylon, type VIII	As required

GLOSSARY

ACB	attitude contrl bar	HQ	headquarters
AFB	Air Force base	in	inch
AFJMAN	Air Force joint manual	LAPE	low-altitude parachute-extraction
AFR	Air Force regulation		
AFTO	Air Force technical order	LAPES	low-altitude parachute-extraction system
attn	attention		
CB	center of balance	lb	pound
d	penny	LRF	laser range finder
DA	Department of the Army	lv	low-velocity
DD	Department of Defense	no	number
diam	diameter	NSN	national stock number
ECU	environmental control unit	PEFTC	extractor force transfer coupling
EFTA	extraction force transfer actuator		(platform)
EFTC	extraction force transfer coupling	PPU	primary power unit
FM	field manual	SL/CS	static line/connector strap
ft	foot	TM	technical manual
GPS	Global Positioning System	TO	technical order
HMMWV	high-mobility, multipurpose wheeled vehicle	TRADOC	United States Army Training and Doctrine Command
		US	United States
		w	with
		yd	yard

REFERENCES

***AFJMAN 24-204/TM38-250/
NAVSUP PUB 505/MCO P 4030.19F/
DLAM 4145.3**

Packaging and Materials Handling: Preparing Hazardous Materials for Military Air Shipment. November 1994.

****FM 10-500-2/To 13C7-1-5**

Airdrop of Supplies and Equipment: Rigging Airdrop Platforms. November 1990.

TM 5-2410-227-15

Operator's Organizational, Direct Support, General Support, and Depot Maintenance Manual: Tractor, Full Tracked, DED, 7500 lb Drawbar Pull Tractor w/ Dozer Blade, Backrip Scarifier (J. I. Case Model M450) (FSN 2410-935-0714) and Loader, Scoop Type w/ Fork Lift Attachment (J. I. Case Model M-450-L) (FSN 3805-131-462). December 1969.

TM 5-2410-231-10

Operator's Manual: Tractor, Full Tracked, Low Speed, DED, 16,000 to 24,900 lb Drawbar Pull, 60 Inch Min Gage, Sectionalized, Air Transportable (Caerpillar Model D5) (FSN 2410-828-6865). August 1968.

TM 10-1670-208-20&P

Organizational Maintenance Manual Including Repair Parts and Special Tools List for Platforms, Types II Modular and LAPES/Airdrop Modular. August 1978.

TM 10-1670-268-20&P

Organizational Maintenance Manual With Repair Parts and Special Tools List: Type V Platform. June 1986.

***AFJMAN24-204/TM38-250 has superseded AFR 71-4/TM 38-250 (15 January 1988). Change 3 reflects this change. The basic manual still references the superseded publication. You may wish to make pen and ink changes to update the old reference citations accordingly.**

****FM 10-500-2/TO 13C7-1-5 has superseded FM 10-500/TO 13C7-1-5 (15 January 1988). Change 3 reflects this change. The basic manual still references the superseded publication. You may wish to make pen and ink changes to update the old reference citations accordingly.**

***TM 10-1670-277-23&P/
TO 13C5-28-2/NAVAIR 13-1-30**

Unit and Intermediate DS Maintenance Manual Including Repair Parts and Special Tools List for Parachute, 28-foot Diam, Extraction. October 1990.

***TM 10-1670-278-23&P/
TO 13C5-26-2/NAVAIR 13-1-27/
TM 01109C-23&P/1**

Unit and Intermediate DS Maintenance Manual Including Repair Parts and Special Tools List for Parachute, 15-foot Diam, Extraction. November 1989.

***TM 10-1670-280-23&P/
TO 13C5-31-2/NAVAIR 13-1-31**

Unit and Intermediate DS Maintenance Manual Including Repair Parts and Special Tools List for Parachute, Cargo Type, G-11A, G-11B, and G-11C. August 1991.

***TM 10-1670-286-20/
TO 13C5-2-41**

Unit Maintenance Manual for Sling/Extraction Line Panel (Including Stowing Procedures). April 1986.

AFTO Form 22

Technical Order Publication Improvement Report

DA Form 2028

Recommended Changes to Publication and Blank Forms. February 1974.

****Shippers Declaration for
Dangerous Goods**

Locally procured form.

***TM 10-1670-277-23&P, TM 10-1670-278-23&P, and TM 10-1670-280-23&P has superseded TM 10-1670-215-20. Change 3 reflects this change. The basic manual still references this superseded publication. You may wish to make pen and ink changes to update the old reference citations accordingly.**

****Shippers Declaration for Dangerous Goods has superseded DD Form 1387-2 (February 1982). Change 3 reflects this change. The basic manual still references the superseded publication. You may wish to make pen and ink changes to update the old reference citations accordingly.**